

8 7 6 5 4 3 2 1

D
C
B
A

D
C
B
A

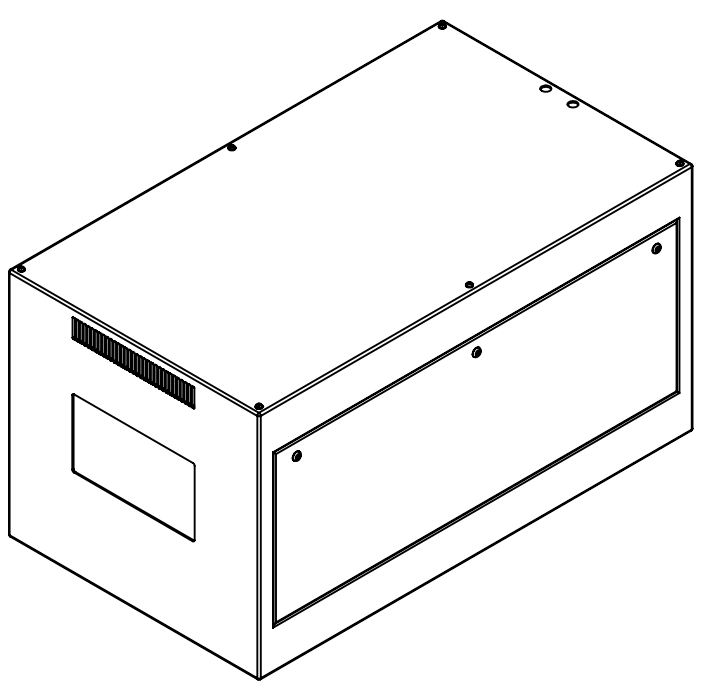
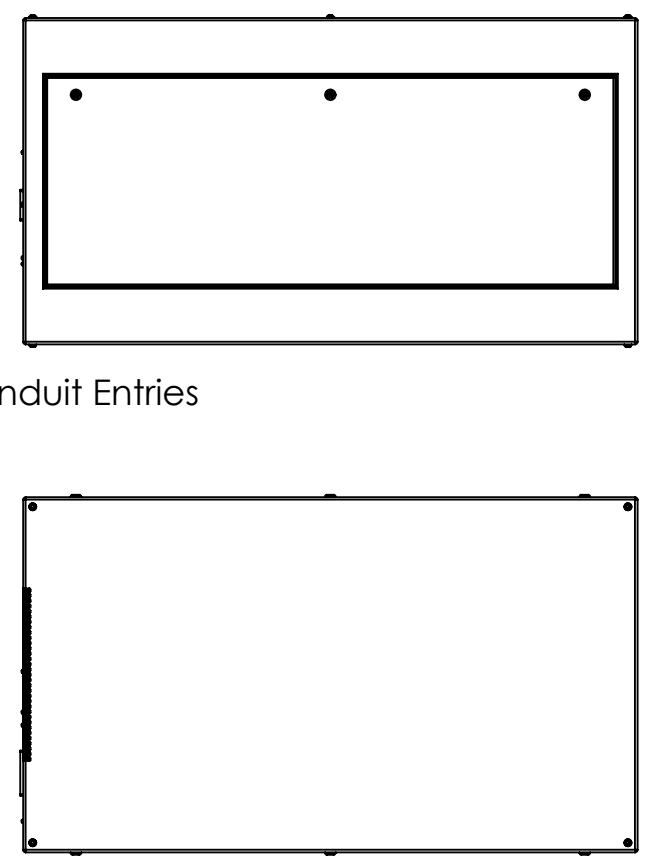
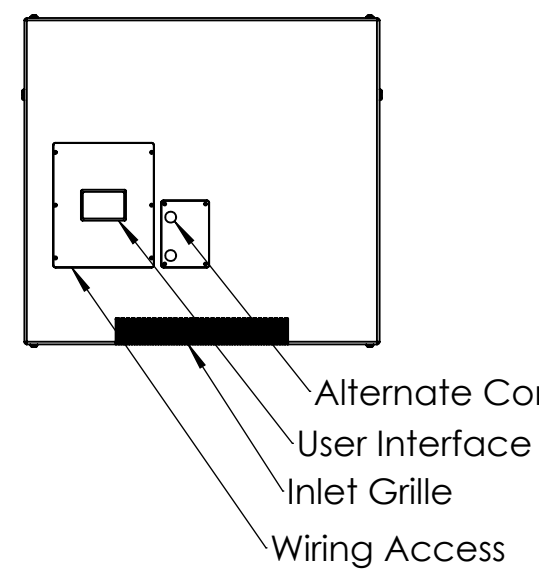
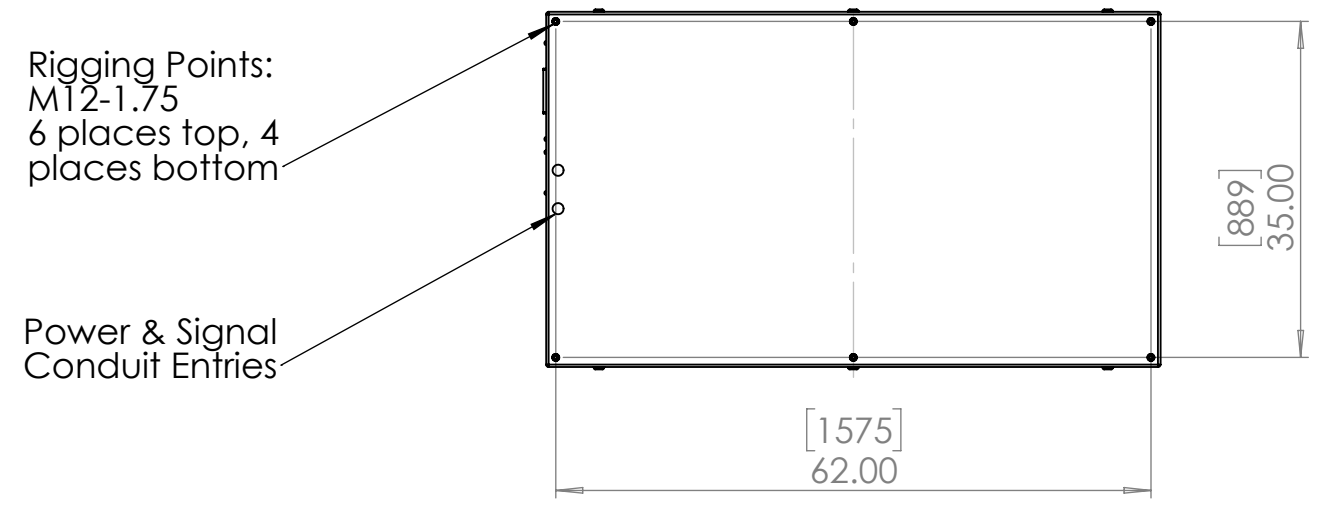
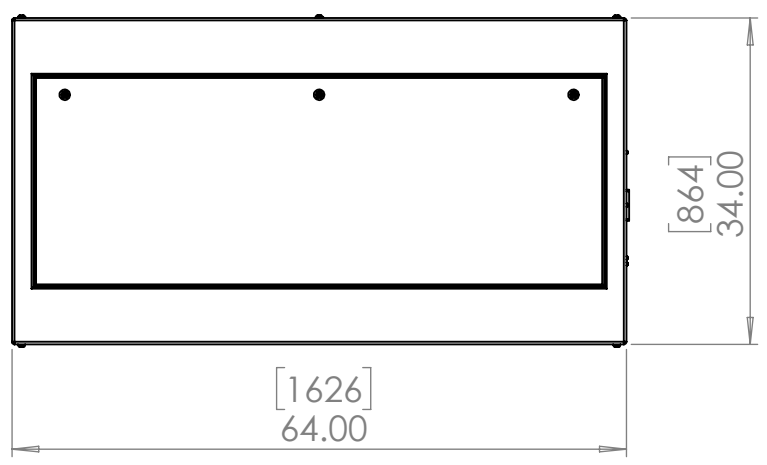
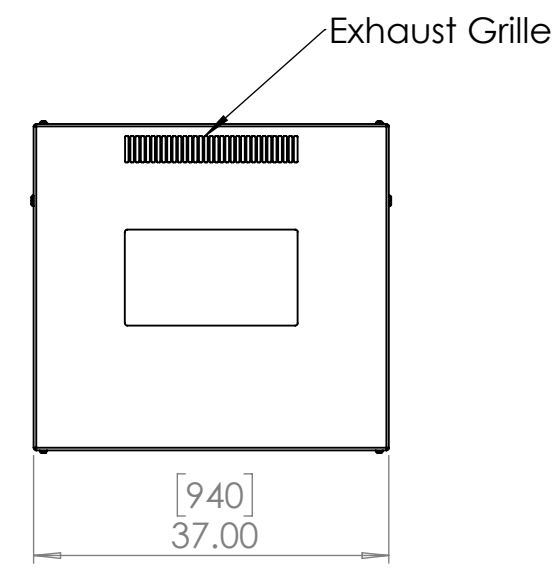

Dimensions may be subject to change - check with Tempest before starting construction work.

UNLESS OTHERWISE SPECIFIED:
DIMENSIONS ARE IN INCHES
TOLERANCES:
FRACTIONAL ±
ANGULAR: MACH ± BEND ±
TWO PLACE DECIMAL ±
THREE PLACE DECIMAL ±
INTERPRET GEOMETRIC
TOLERANCING PER:
MATERIAL
Aluminum
FINISH
Powder Coat RAL
9003 White
DO NOT SCALE DRAWING

	NAME	DATE
DRAWN	TB	4/22/2021
CHECKED		
ENG APPR.		
MFG APPR.		
Q.A.		
COMMENTS:		



TEMPEST
lighting inc.

TITLE:
Zen 57.525 Enclosure

SIZE B	DWG. NO. 57.525.L	REV 11
SCALE: 1:20		SHEET 1 OF 1