

For Remote Fan Module, see drawing # 51.RFA.270.PWM

D

C

B

A

D

C

B

A

Rigging Points:  
M12-1.75,  
4 places top and bottom

Alternate Conduit Entries

Exhaust Duct Ring

Inlet Duct Ring

User Interface

Wiring Access

Power & Signal Conduit Entries

[251]  
Ø 9.90

[914]  
36.00

[1219]  
48.00

[508]  
20.00

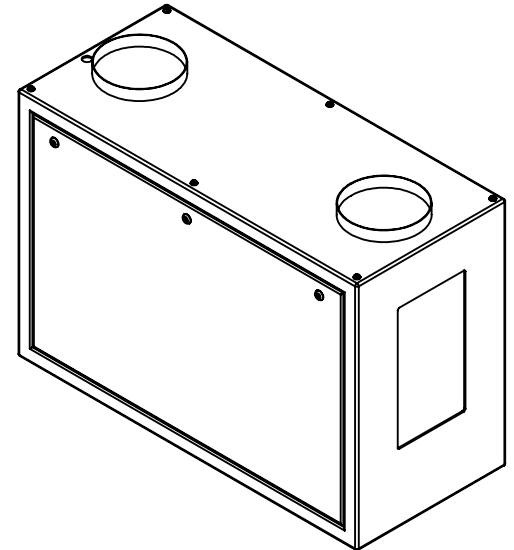
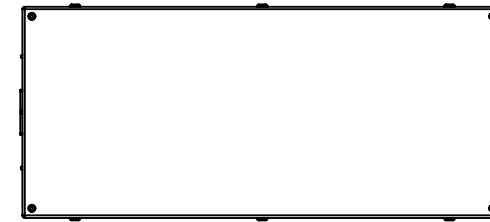
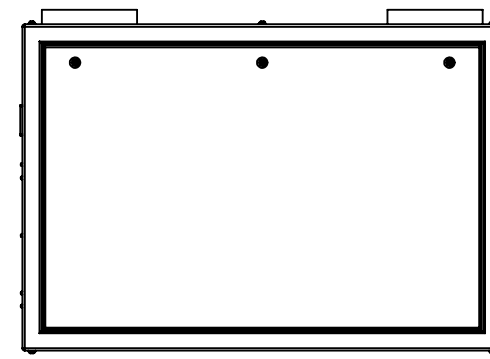
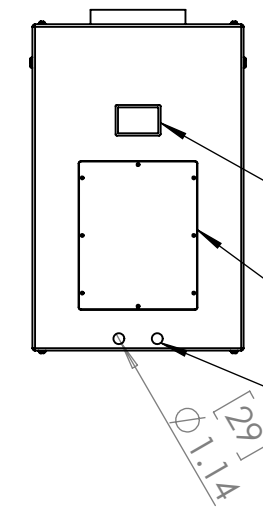
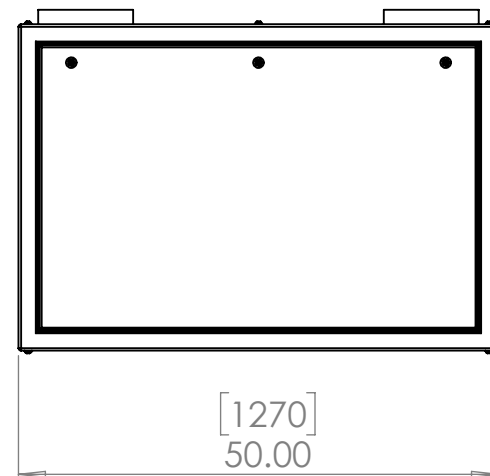
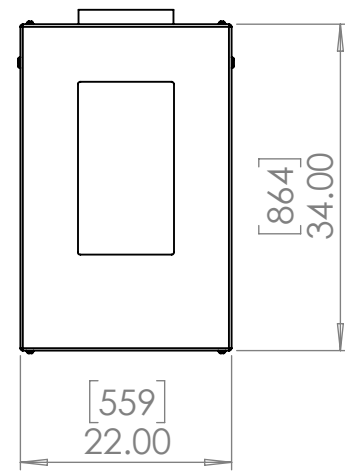

UNLESS OTHERWISE SPECIFIED:  
DIMENSIONS ARE IN INCHES  
TOLERANCES:  
FRACTIONAL ±  
ANGULAR: MACH ± BEND ±  
TWO PLACE DECIMAL ±  
THREE PLACE DECIMAL ±  
INTERPRET GEOMETRIC  
TOLERANCING PER:  
MATERIAL  
Aluminum  
FINISH  
TBD  
DO NOT SCALE DRAWING

	NAME	DATE
DRAWN	TB	9/10/2022
CHECKED		
ENG APPR.		
MFG APPR.		
Q.A.		
COMMENTS:		



**TEMPEST**  
lighting inc.

TITLE:  
Tacit 56.250 Portrait  
Enclosure

SIZE <b>B</b>	DWG. NO. 56.250.P	REV 08
------------------	----------------------	-----------

SCALE: 1:10 SHEET 1 OF 1

Dimensions are subject to change. Check with Tempest before starting any construction work.