



Oasis

IP66 Outdoor
Projection Active
Cooling Systems



Oasis

IP66 Outdoor Projection Active Cooling Systems

Now you can safely operate sensitive laser projectors in any environment with temperatures from -15 to 50°C (5-122°F), while maintaining a CONSTANT temperature where you need it — at the projector air inlet.

Get the maximum life out of your laser light engine, and say goodbye to RGB color shift with changing ambient temperatures.

Oasis uses highly efficient inverter heat pump technology to maintain its set temperature regardless of outside conditions, either when the system detects the projector is active, or when the internal temperature reaches a user-set temperature with the projector in standby mode.

In low ambient temperatures, Oasis maintains a minimum temperature, using a thermostatically controlled heater inside the enclosure.

Oasis models are tailored specifically for each projector type, from 5,000 to 50,000 lumens.

Each Oasis model has been tested and approved with its designated projector before being released for production.

Oasis comes with all the features you expect from Tempest:

- *IP66 Protection Class*
- *Landscape, portrait, and many UST lens options*
- *Many rigging options*
- *Tough Aluminum welded construction*
- *Large access doors both sides for projector access*

- *User interface for setup and monitoring*
- *Available TCP/IP, RDM, or web-based monitoring*

Oasis comes as standard with 5m (16') line set connecting the suit-case-style compressor unit with the enclosure. A simple and inexpensive installation process is easily handled

by any local HVAC installer.

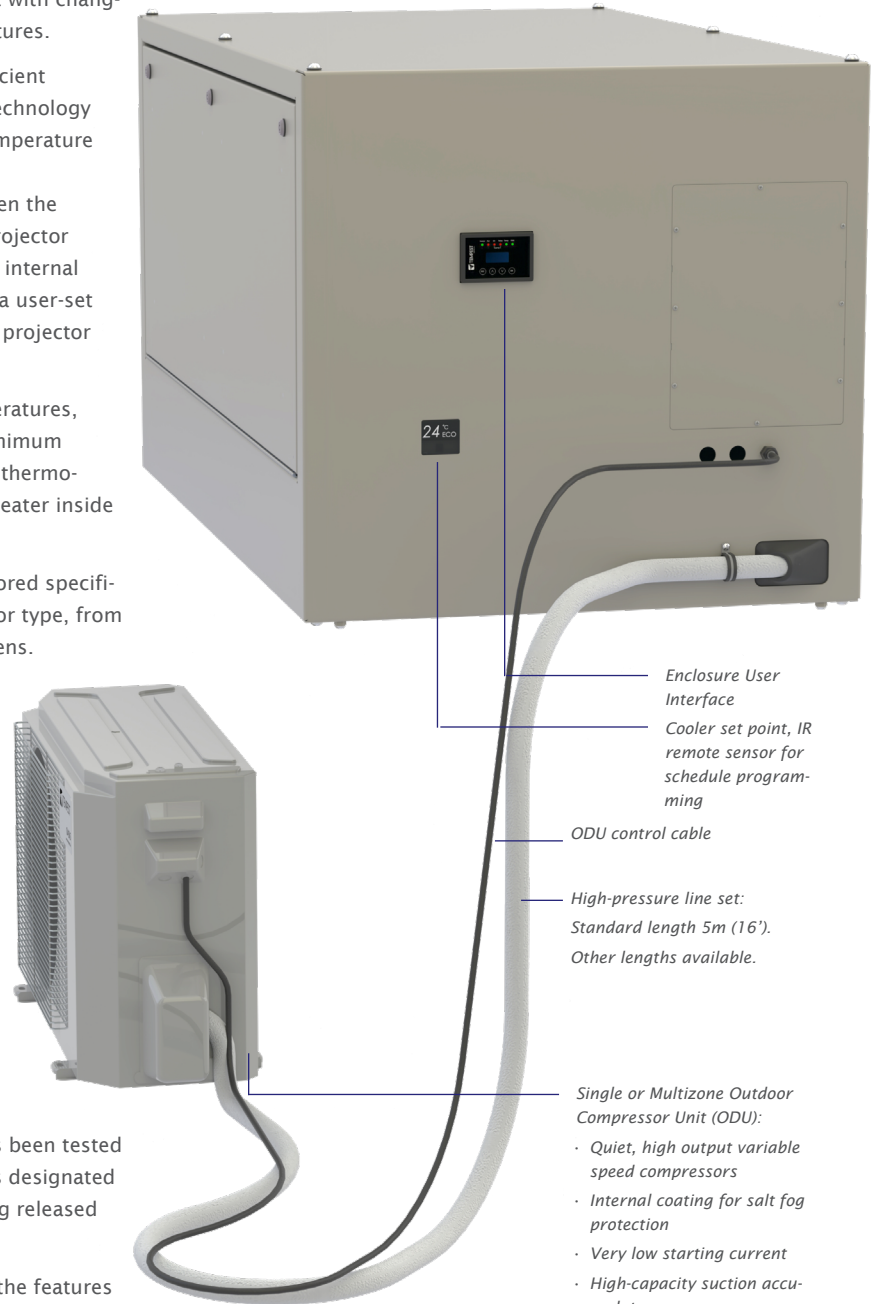

Enclosure User Interface
Cooler set point, IR remote sensor for schedule programming

ODU control cable

High-pressure line set:
Standard length 5m (16').
Other lengths available.

Single or Multizone Outdoor Compressor Unit (ODU):

- *Quiet, high output variable speed compressors*
- *Internal coating for salt fog protection*
- *Very low starting current*
- *High-capacity suction accumulators*
- *Optional heavy-duty vibration mounts*
- *Durable outdoor fan with high glass content*
- *Efficient, permanently lubricated EC/DC outdoor motor*
- *Internal overload protection*
- *Flare type refrigerant connections*
- *R410A Refrigerant*
- *ETL Outdoor Rating*

Oasis

IP66 Outdoor
Projection
Active Cooling
Systems

Single Systems, Multizone Systems

A single projector? No problem. Your Oasis enclosure comes with its own dedicated compressor (ODU), and interconnecting line set — everything you need.

But it often happens on big mapping jobs that projectors will be grouped around the site, in clusters of two or more. That's where Oasis Multizone systems come in. Now you need only a single multizone ODU to serve up to five Oasis enclosures.

Multi-zone systems still give you individual temperature and scheduling control for each enclosure, and the projector and enclosure types don't have to be the same, so Oasis Multi is both practical and extremely flexible.

The maximum line set length from ODU to enclosure is 15m (50ft), so the enclosures in each multi-zone cluster don't even have to be so close together!

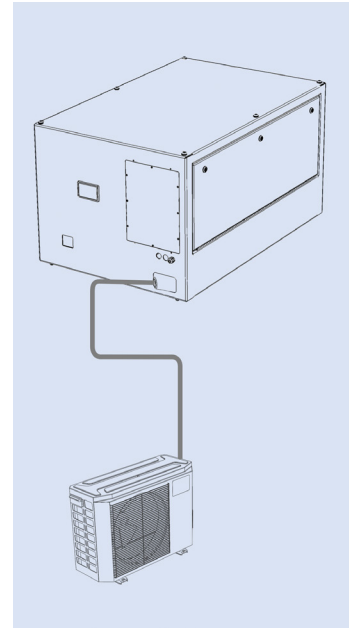

Oasis 59.310 Enclosure, complete with ODU and line set.

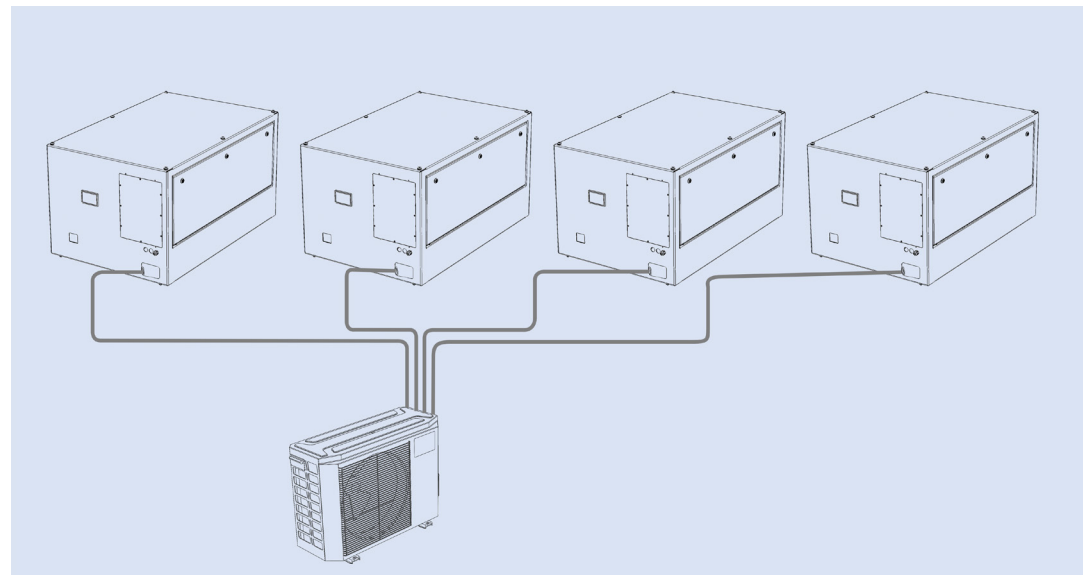

Four Oasis Enclosures, complete with Multi-zone ODU and line sets.

The number and heat load of the projectors in each Multi-zone Oasis system will affect the selection of components for each system.

Please contact Tempest to discuss the optimal configuration for your Oasis Multizone systems.

Oasis

IP66 Outdoor
Projection
Active Cooling
Systems

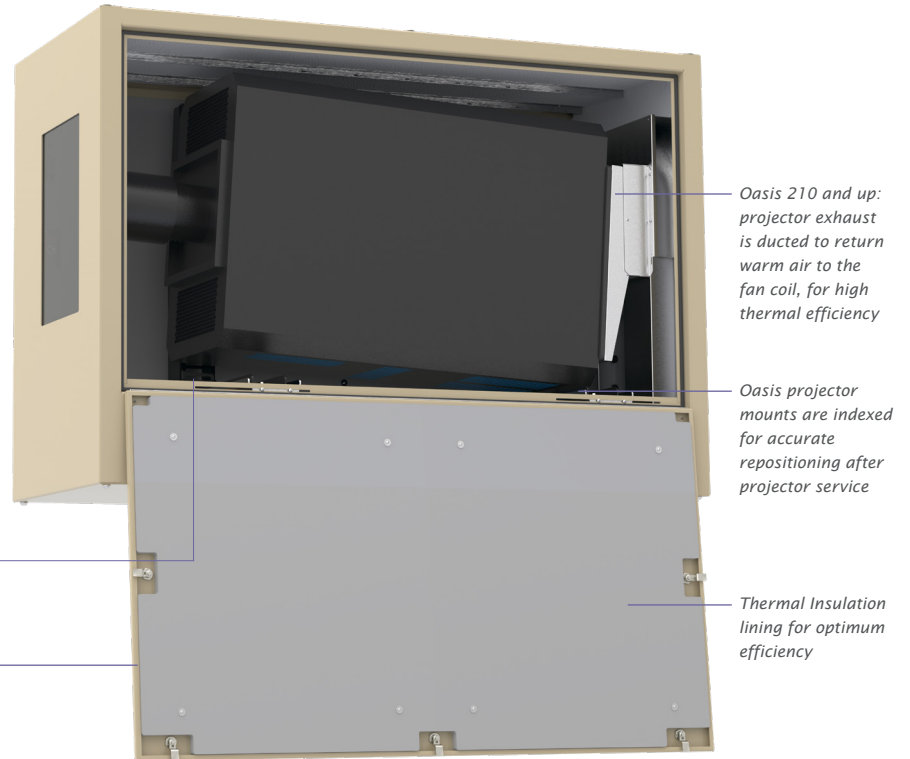

Oasis 210 and up: projector exhaust is ducted to return warm air to the fan coil, for high thermal efficiency

Oasis projector mounts are indexed for accurate repositioning after projector service

Thermal Insulation lining for optimum efficiency

Portrait Oasis enclosures allow $\pm 5^\circ$ tilt adjustment to compensate for limited H-shift

Large, insulated access doors both sides for excellent projector access

Oasis 59.525P Portrait Enclosure, with Panasonic PT-RZ50K

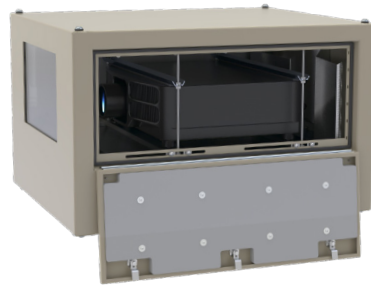

Oasis 59.1xx models come with universal projector mounts: if the projector fits, it works.

Automatic Operation

Just set the desired temperature set point and upper and lower temperature limits, and we'll take care of the rest.

Tempest's patented Digital Enclosure Control (DEC) technology makes sure that the cooler runs when either the projector is on, or the daytime temperature exceeds your preset target.

The cooler automatically maintains the set point at all times, within a very tight margin, due to Oasis' variable speed inverter technology. And you can even set different set points for different times of day!

Cold? Don't worry — Oasis' heater maintains a minimum preset temperature in cold climates, so the projector will never have trouble firing up at show time.

Important: If ambient temperatures below -15°C (-5°F) are expected, consult Tempest.

Simple Installation

All wiring connections are easily accessible via the enclosure back panel.

The high-pressure line set connections must be made by a licensed HVAC installer. This is a simple process, identical to setting up a mini-split AC unit.

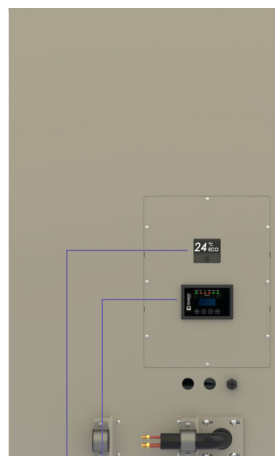

DEC User Interface
Cooler set point display
and IR sensor

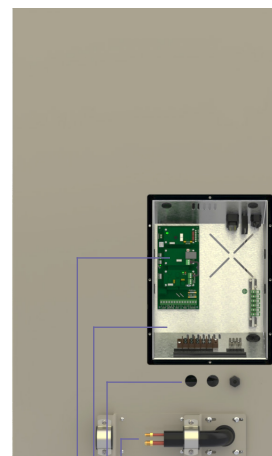

Line set Connections
Power & signal conduit entries
Wiring compartment
DEC enclosure controller

Oasis

IP66 Outdoor
Projection
Active Cooling
Systems

Rigging Options

All Oasis enclosures come with six M12 threaded sockets on the top surface, and four on the bottom. So you can bolt the enclosure directly to your structure, or use them to attach these Tempest rigging accessories.

Stainless steel bolts are provided for attachment to any suitable support structure.

Tempest recommends only the use of stainless steel hardware for installing enclosures outdoors.

Unistrut Kit

Easy attachment to any structure using these two Unistrut rails. Use standard Unistrut hardware to attach to your structure, without worrying about precise hole locations.

Unistruts may be mounted top (shown here) or bottom; please specify with order.

Note: A Unistrut Kit is required for use with Cyclovator.

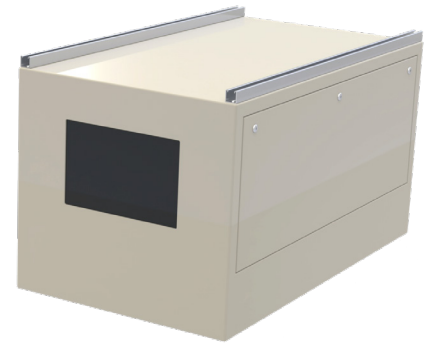

NOTE: Cyclovator requires 59.UR.xxx Unistrut Rail Kit

Cyclovator

Our fabled Cyclovator tucks snugly under the center of gravity of the enclosure.

Use Cyclovator on the ground to cover tall buildings, or on a rooftop to project to ground level. Either way, Cyclovator allows you to project up to about 60° off horizontal, and then bring the projector safely back to horizontal for service access.

You can even bolt this Cyclovator to a truss or other structure and use it to hang any Oasis enclosure at any angle.

And Cyclovator has a positive index ring that you set to come back to your show position with absolute repeatability, time after time...

Angle Mount

A simple fixed angle mounting kit, with a range 10-45° up (shown here) or down — simply mount with the enclosure facing the other way.

55.AM2 Oasis 210-305

55.AM3 Oasis 310, 314, 322

55.AM4 Oasis 320, 514, 525

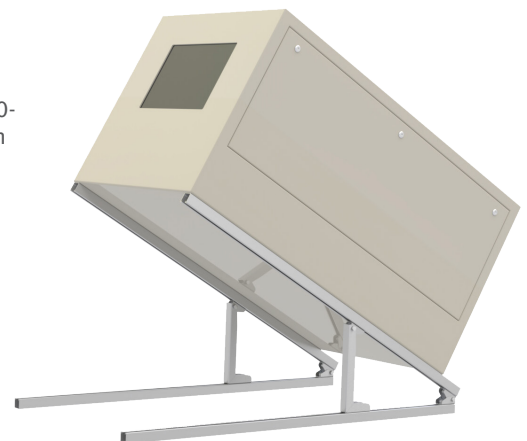

Oasis

IP66 Outdoor
Projection
Active Cooling
Systems

Sun Shade

This aluminum panel mounts easily on the top of any Oasis enclosure to provide extra daytime protection in hot, sunny climates. The cover not only deflects sunlight, but also provides a 75mm (3in) air gap between the shade and the enclosure top, promoting convective air movement. Use in sunny areas with daytime temperatures frequently above 35°C (95°F).



Stacking Kit

Stack two or more Oasis enclosures of the same type using this stacking kit.

Male and female parts attach to the threaded corner holes, and are simply joined together using stainless steel clevis pins.

Maximum two enclosures stacked if hung, up to three with ground support.



Swivel Stacking Kit

Stack two Oasis enclosures (must be the same model), and angle them horizontally up to 40 degrees apart — handy for short-throw edge blending jobs.

Stainless steel stacking kits attach to M12 rigging points, and locking bolts are provided to secure rotation angle when aligned.



Custom Rigging Options

Don't see what you need? We do a lot of custom designs and we'll be happy to work with you to find the best solution for your project.

Oasis

IP66 Outdoor
Projection
Active Cooling
Systems

August 2022, and the first Oasis installation is just weeks away...

Needless to say, this project, in steamy New Orleans, features Panasonic PT-RQ50 projectors, most of them in portrait mode.

The engineering prototype tests had all gone well — but with much smaller RZ21K projectors. Would the new system hold up to the 50,000 lumens of the mighty RQ50s?

There's only one way to find out. Tempest engineers have set up the first Oasis 59.525.P enclosure in our Southern California warehouse, where summer days get pretty warm.

The projector arrives, and is quickly installed. A final check, all systems look good. The projector is connected to a laptop for monitoring, thermocouples attached and calibrated, the enclosure doors closed.

10.30am. Power on.

Projector on — 100% bright.

Oasis set point — 20°C

Ambient — 29°C

Coffee time...

11:30 — all good.

12:30 — all good.

...it's a long day...

18:30 — all good. But now the

ambient is 34°C — and the projector intake temperature has been rock solid: 20-21°C the entire time, with fluctuations <1°C.

Success!

The Acid Test

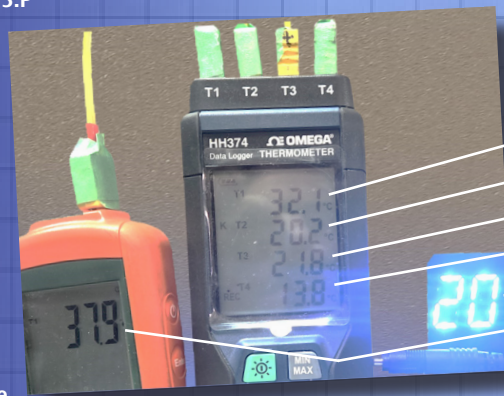
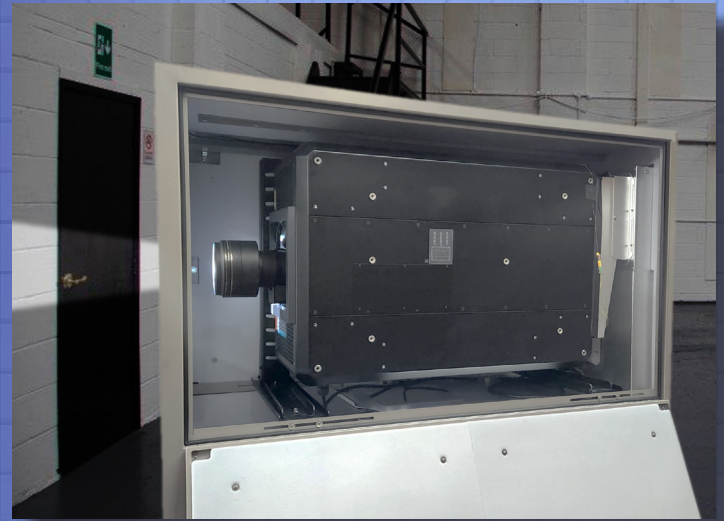

3:30pm — ambient now 32°C. These displays are connected to thermocouples inside the enclosure:

- Ambient
- Projector front inlet
- Projector top inlet
- Cool air flow (fan coil)
- Oasis Cooler Set Point
- Projector exhaust

4:30pm: The enclosure sensor above the port glass has been reading 19°C all day. But the relative humidity has dropped from 63% to 45%. It's DRY in there!



Projector Control Window			
Status	Projector status	Network status	Access error log
PROJECTOR TYPE	PT-RQ50K	SERIAL NUMBER	SE1640001
MAIN VERSION	3.05	NETWORK VERSION	1.04
POWER	ON STANDBY	REMOTE STATUS	ENABLE DISABLE
SHUTTER	CLOSE OPEN	OSD	ON OFF
OPERATING MODE	NORMAL	AC VOLTAGE	230 V
MAX LIGHT OUTPUT LEVEL	100.0 %	LIGHT OUTPUT	100.0 %
INPUT	HDMI3 (SLOT2)	3840x2160@30p (67.43Hz/25.97Hz)	
INTAKE AIR TEMPERATURE	21°C / 69°F		
EXHAUST AIR TEMPERATURE	37°C / 98°F		
TEMPERATURE INFORMATION (Detail)			
LIGHT1	ON OFF	RUNTIME	24 H
LIGHT2	ON OFF	RUNTIME	24 H
PROJECTOR RUNTIME	24 H	SELF TEST	No errors

6:30pm: The system has been running over six hours. The projector intake temp has been rock solid at 20-21°C the entire time, fluctuations <1°C

Oasis

IP66 Outdoor
Projection
Active Cooling
Systems

Tempest System Manager

Tempest System Manager is a Windows app running on a local PC connected to your enclosures over a local area network.

TSM discovers any Tempest enclosures present on the network at initialization, and monitors system attributes in real time, including lamp, fan and heater status, temperature, relative humidity and more.

TSM may also be used to upload firmware updates to enclosure controllers over the network, without having to visit each enclosure.

The TSM license includes 12 months unlimited user support from Tempest electronics partner JESE, and continuing support is available for a modest annual fee.

Index	Description	Label	Status	Voltage	Current	RH%	Temp °C	Htr %	Fan %
1	DEC4 Controller	Cyclone 310 Left 1	Lamp On	231V	12.2A	45.7%	23.4°C	0.0%	100.0%
2	DEC4 Controller	Cyclone 310 Left 2	Lamp on	231V	12.2A	46.0%	23.8°C	0.0%	100.0%
3	DEC4 Controller	Cyclone 310 Left 3	Override	231V	0.0A	49.4%	22.6°C	0.0%	0.0%
4	DEC4 Controller	Cyclone 310 Left 4	Tripped	231V	0.1A	1.2%	66.2°C	0.0%	100.0%
5	DEC4 Controller	Cyclone 310 Left 5	Lamp on	231V	12.2A	46.1%	23.4°C	0.0%	100.0%
6	DEC4 Controller	Cyclone 310 Left 6	Lamp on	231V	12.2A	46.3%	23.5°C	0.0%	100.0%
7	DEC4 Controller	Cyclone 310 Right 1	Lamp on	231V	12.2A	46.4%	23.8°C	0.0%	100.0%
8	DEC4 Controller	Cyclone 310 Right 2	Lamp on	231V	12.2A	46.3%	23.5°C	0.0%	100.0%
9	DEC4 Controller	Cyclone 310 Right 3	Lamp on	231V	12.2A	46.0%	23.2°C	0.0%	100.0%
10	DEC4 Controller	Cyclone 310 Right 4	Lamp on	231V	12.2A	46.1%	23.1°C	0.0%	100.0%
11	DEC4 Controller	Cyclone 310 Right 5	Lamp on	231V	12.2A	46.0%	23.7°C	0.0%	100.0%
12	DEC4 Controller	Cyclone 310 Right 6	Lamp on	231V	12.2A	46.2%	23.4°C	0.0%	100.0%
13	DEC4 Controller	ard 100 UST 1	Standby	231V	0.2A	51.3%	22.1°C	0.0%	0.0%
14	DEC4 Controller	ard 100 UST 2	Standby	231V	0.2A	51.8%	22.0°C	0.0%	0.0%
15	DEC4 Controller	ard 100 UST 3	Standby	231V	0.2A	51.4%	22.2°C	0.0%	0.0%
16	DEC4 Controller	ard 100 UST 4	Standby	231V	0.2A	51.3%	22.3°C	0.0%	0.0%
17	DEC4 Controller	ard 100 UST 5	Standby	231V	0.2A	51.3%	21.8°C	0.0%	0.0%
18	DEC4 Controller	ard 100 UST 6	Standby	231V	0.2A	51.6%	22.1°C	0.0%	0.0%
19	DEC4 Controller	ard 100 UST 7	Standby	231V	0.2A	51.5%	21.4°C	0.0%	0.0%
20	DEC4 Controller	Blizzard 100 UST 8	Standby	231V	0.2A	51.7%	22.2°C	0.0%	0.0%

Monitoring Connections

There are two ways to connect enclosures to the TSM PC:

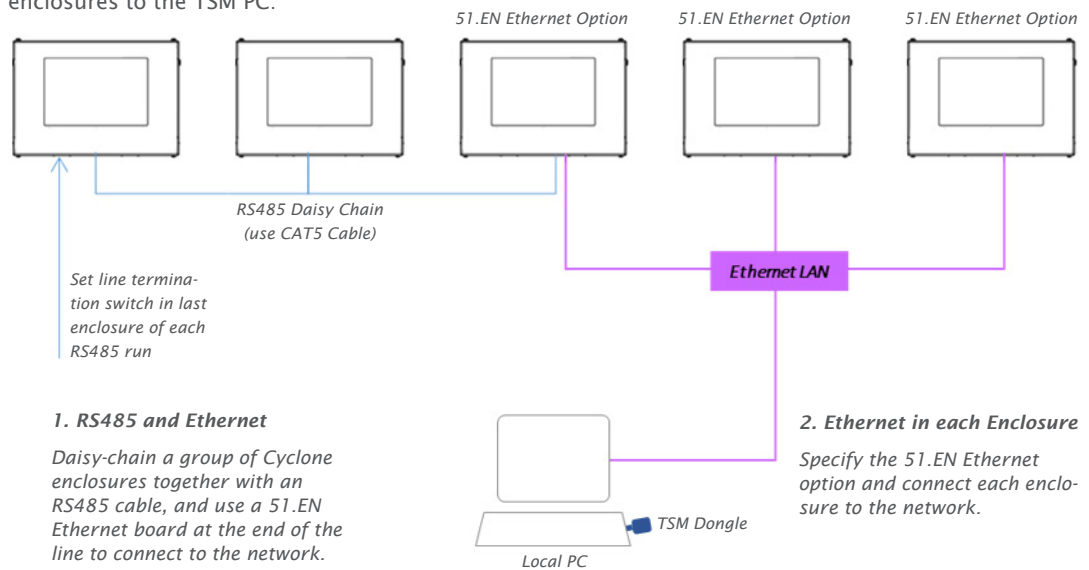

TSM Model Numbers

- 51.TSM.10 Up to 10 enclosures
- 51.TSM.25 Up to 25 enclosures
- 51.TSM.50 Over 25 enclosures

TEMP Protocol

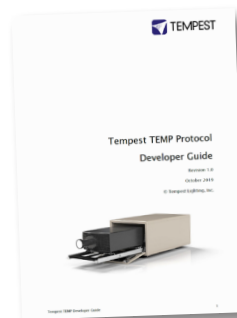

Tempest also publishes a simple protocol for use by integrators wishing to monitor enclosures over an existing control network.

Connection options are the same as for System Manager.

Download the TEMP Developer Guide [here](#):

Oasis Ordering Guide

Oasis Projector Enclosure Dimensions ¹			Enclosure/ODU									Shipping							
Model	Orientation ²	Typical Projectors ³	L (cm)	W (cm)	H (cm)	Kg	L (in)	W (in)	H (in)	Lb	ODU	L (cm)	W (cm)	H (cm)	Kg	L (in)	W (in)	H (in)	Lb
59.100.L	Landscape	Most, 7-10,000 Lumens	102	81	61	70	40	32	24	154	9k	122	102	86	106	48	40	34	234
59.100.P	Portrait		102	56	97	76	40	22	38	167	9k	122	76	122	112	48	30	48	247
59.125.L	Landscape	Panasonic PT-MZ Series	102	94	61	81	40	37	24	178	9k	122	114	86	117	48	45	34	258
59.125.P	Portrait		102	56	112	86	40	22	44	189	9k	122	76	137	122	48	30	54	269
59.150.L	Landscape	Most 12-15,000 Lumens	122	81	66	91	48	32	26	201	9k	142	102	91	128	56	40	36	281
59.150.P	Portrait		122	56	97	92	48	22	38	201	9k	142	76	122	128	56	30	48	281
59.200.L	Landscape	Epson EB-PU 22xx	91	86	61	66	36	34	24	144	9k	112	107	86	102	44	42	34	224
59.200.P	Portrait		91	56	107	74	36	22	42	162	9k	112	76	132	110	44	30	52	242
59.202.L	Landscape	Panasonic PT-RQ25K, DPI M-Vision 23K	117	76	61	77	46	30	24	170	9k	137	97	86	114	54	38	34	250
59.202.P	Portrait		117	56	91	85	46	22	36	187	9k	137	76	117	121	54	30	46	267
59.204.L	Landscape	Christie M4K-25	122	76	66	79	48	30	26	175	9k	142	97	91	116	56	38	36	255
59.204.P	Portrait		122	56	91	84	48	22	36	186	9k	142	76	117	121	56	30	46	266
59.210.L	Landscape	Panasonic PT-RZ21K, Barco G100	132	86	66	105	52	34	26	231	9k	152	107	91	141	60	42	36	311
59.210.P	Portrait		132	56	102	105	52	22	40	230	9k	152	76	127	141	60	30	50	310
59.250.L	Landscape	Epson L-30000	132	94	66	121	52	37	26	265	12k	152	114	91	157	60	45	36	345
59.250.P	Portrait		132	61	117	118	52	24	46	259	12k	152	81	142	154	60	32	56	339
59.305.L	Landscape	Panasonic PT-RQ35K, RZ34K, Barco UDM	137	81	76	115	54	32	30	252	12k	157	102	102	162	62	40	40	357
59.305.P	Portrait		137	61	97	113	54	24	38	248	12k	157	81	122	160	62	32	48	353
59.310.L	Landscape	Barco UDX 40K	142	86	71	124	56	34	28	273	12k	163	107	97	172	64	42	38	378
59.310.P	Portrait		142	61	102	125	56	24	40	276	12k	163	81	127	173	64	32	50	381
59.314.L	Landscape	Christie Griffyn 32K	152	86	76	134	60	34	30	294	12k	173	107	102	182	68	42	40	399
59.314.P	Portrait		152	61	102	131	60	24	40	288	12k	173	81	127	179	68	32	50	393
59.322.L	Landscape	DPI Titan Laser 37K	147	94	76	158	58	37	30	348	18k	168	114	102	206	66	45	40	453
59.322.P	Portrait		147	71	117	170	58	28	46	375	18k	168	91	142	218	66	36	56	480
59.514.L	Landscape	Christie Griffyn 50K	152	94	76	154	60	37	30	339	18k	173	114	102	202	68	45	40	444
59.514.P	Portrait		152	71	112	172	60	28	44	379	18k	173	91	137	220	68	36	54	484
59.522.L	Landscape	DPI Insight 8K 37K	168	94	86	218	66	37	34	480	18k	188	114	112	275	74	45	44	605
59.522.P	Portrait		168	71	127	211	66	28	50	464	18k	188	91	152	268	74	36	60	589
59.525.L	Landscape	Panasonic PT-RQ50K	168	91	81	175	66	36	32	384	18k	188	112	107	231	74	44	42	509
59.525.P	Portrait		168	71	107	178	66	28	42	392	18k	188	91	132	235	74	36	52	517
59.ODU.09	ODU 9k BTU		77	30	56	30	30	12	22	66	9k	90	35	60	33	35	14	24	73
59.ODU.12	ODU 12k BTU		80	33	55	32	31	13	22	70	12k	92	39	62	35	36	15	24	77
59.ODU.18	ODU 18k BTU		80	33	55	36	31	13	22	79	18k	92	39	62	39	36	15	24	86
59.ODU.MZ2/23	ODU 2-Zone/23k BTU		89	34	67	46	35	13	26	101	23k	103	44	75	50	41	17	30	110
59.ODU.MZ3/32	ODU 3-Zone/32k BTU		95	41	81	64	37	16	32	141	32k	109	50	89	68	43	20	35	150
59.ODU.MZ4/40	ODU 4-Zone/40k BTU		95	41	81	77	37	16	32	169	40k	109	50	89	82	43	20	35	180
59.ODU.MZ5/50	ODU 5-Zone/50k BTU		95	42	133	102	37	17	52	224	50k	110	50	148	117	43	20	58	257

¹ Due to continuous product development, weights and dimensions are subject to change. Check with Tempest before construction work.

² Landscape and Portrait versions shown here. UST versions are custom or semi-custom. Please consult Tempest for details

³ For projectors not shown here, please contact Tempest — we will be happy to accommodate any projector type

All Oasis products are built to order. Please contact Tempest for lead times.

All sales are subject to Tempest Lighting, Inc. Standard Terms and Conditions of Sale, available for download at www.tempest.biz.

All Schedule B Export Code: 9405.99.0000

Custom Colors

Most enclosures in this brochure are shown in our popular standard light bronze finish.

White, Black or any RAL color are available to special order. See the color section in the Cyclone Configurator on the next page.

Available Options

- | | | | |
|--------------------|---|--------------------|--|
| 59.VM | Vibration mount kit for any Oasis Outdoor Unit | 55.AM2 | Angle Mount Kit, Oasis 200-305 |
| 59.UR.xxx | Unistrut Rail Kit (Use the 3-digit enclosure model #, eg 59.UR.525) | 55.AM3 | Angle Mount Kit, Oasis 310, 314, 324 |
| 51.SK | Stacking Kit | 55.AM4 | Angle Mount Kit, Oasis 320, 525 |
| 51.SS.xxx.x | Swivel Stacking Kit (xxx.x = Oasis model #) | 59.SH.xxx.x | Sun Shade (xxx.x = Oasis model #) |
| 55.C2 | Cyclovator 2 (requires 55.UR.xxx) | 51.EN | Ethernet Adapter (for system monitoring) |
| 52.AM.100 | Angle Mount Kit, Oasis 100, 125 | 51.TSM.xx | Tempest System Manager |
| 52.AM.150 | Angle Mount Kit, Oasis 150 | 55.WW | Windshield Wiper Kit |

For custom options please consult Tempest

CAD drawings and user manuals at www.tempest.biz

Oasis Configurator

Please complete this form and email to us at info@tempest.biz

Name		
Company		
Email		
Phone		
Project Name & Location		
Projector & Lens Make/Model #	Projector:	Lens:
Oasis Model	59. _____	
Quantity		
Destination Country		
Install Date		
Enclosure Type	Landscape <input type="checkbox"/> Portrait <input type="checkbox"/> UST <input type="checkbox"/>	
Required Options		
Line Set Length	3m <input type="checkbox"/> 5m <input type="checkbox"/> 8m <input type="checkbox"/> 10m <input type="checkbox"/> 15m <input type="checkbox"/>	
ODU Vibration Mount	Yes, Qty _____ No <input type="checkbox"/>	
Sun Shade	Yes, Qty _____ No <input type="checkbox"/>	
Cyclovator	Yes, Qty _____ No <input type="checkbox"/>	
Angle Mount Kit	Yes, Qty _____ No <input type="checkbox"/>	
Stacking Kit	Yes, Qty _____ No <input type="checkbox"/>	
Swivel Stacking Kit	Yes, Qty _____ No <input type="checkbox"/>	
Unistrut Kit	Yes, Qty _____ No <input type="checkbox"/> <i>Mounting: Top</i> <input type="checkbox"/> <i>Bottom</i> <input type="checkbox"/>	
Ethernet Comms	Yes, Qty _____ No <input type="checkbox"/> 51.D4.23 (TSM) <input type="checkbox"/> 51.D4.15 (TEMP) <input type="checkbox"/>	
Windshield Wiper	Yes, Qty _____ No <input type="checkbox"/>	
Projector Power Outlet (all types include 2 x IEC 60320 C13 Aux Power):		
IEC 60320 C19 20Amp _____ <input type="checkbox"/>		
IEC 60309 30/32Amp _____ <input type="checkbox"/>		
Custom (specify) _____ <input type="checkbox"/>		
Color, standard	Light Bronze <input type="checkbox"/> Black <input type="checkbox"/> White <input type="checkbox"/>	
Color, custom	Custom, RAL # _____ Gloss Level _____% Salt Fog Primer Yes <input type="checkbox"/> No <input type="checkbox"/>	

UST Lens Configuration:

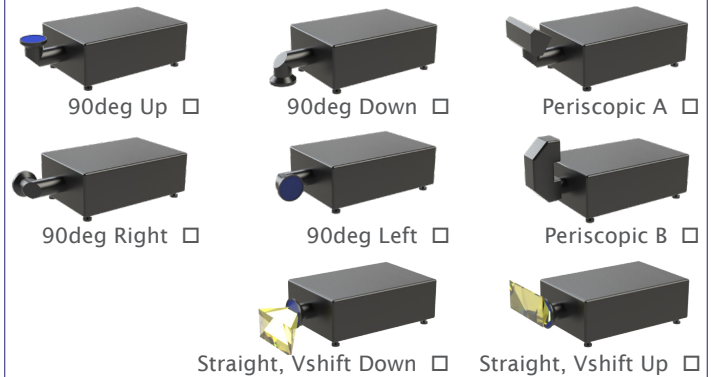

Multizone Systems:

Please download the Oasis Multizone Configurator from our [web site](http://www.tempest.biz), complete, and email to info@tempest.biz.

Custom Requests:

Factory Use Only:

SO Number	
Date	
Electrical	IEC <input type="checkbox"/> NEMA <input type="checkbox"/>

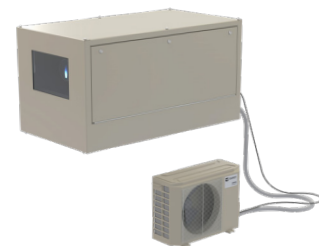

User manuals and CAD drawings: www.tempest.biz

 Made in the USA
©Tempest Lighting, Inc., September 2022
In the interest of continuous product improvement, specifications are subject to change without notice

Tempest Lighting, Inc.,
11845 Wicks Street, Sun Valley, CA 91352, USA
www.tempest.biz info@tempest.biz
t: +1 818 787 8984 f: +1 818 252 7101