

Line Set (high-pressure pipes and cooler control cable), choose from:

- 59.LS.12.03 - 3m [10ft] [ ] (default)
- 59.LS.12.05 - 5m [16ft] [ ]
- 59.LS.12.08 - 8m [25ft] [ ]
- 59.LS.12.10 - 10m [33ft] [ ]
- 59.LS.12.15 - 15m [50ft] [ ]

For single-zone systems, see ODU drawing 59.ODU.12

For multi-zone systems, consult Tempest for ODU specification.

Rigging Points:  
M12-1.75,  
6 places Top  
4 Places Bottom

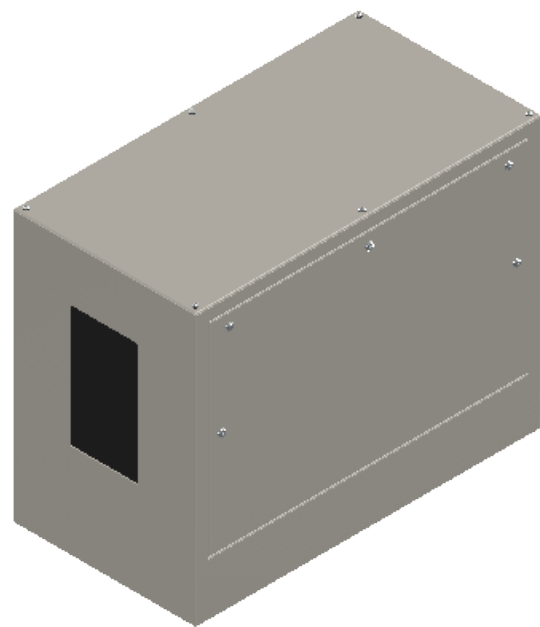
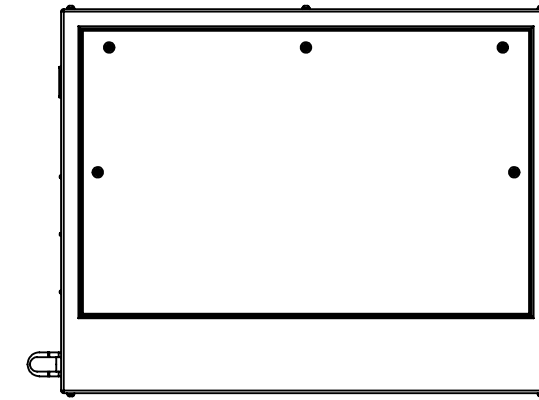
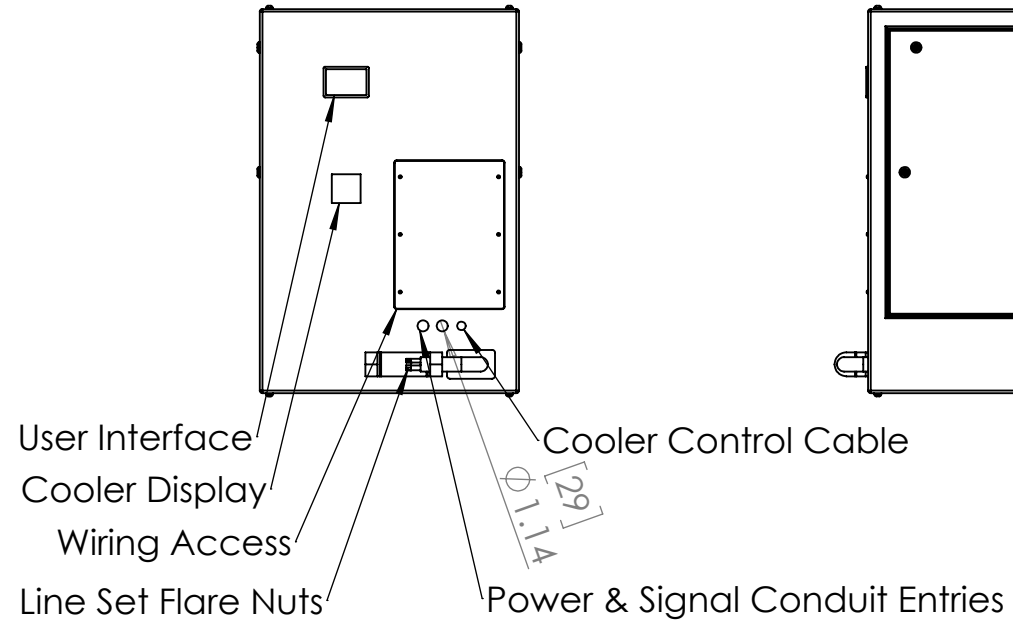
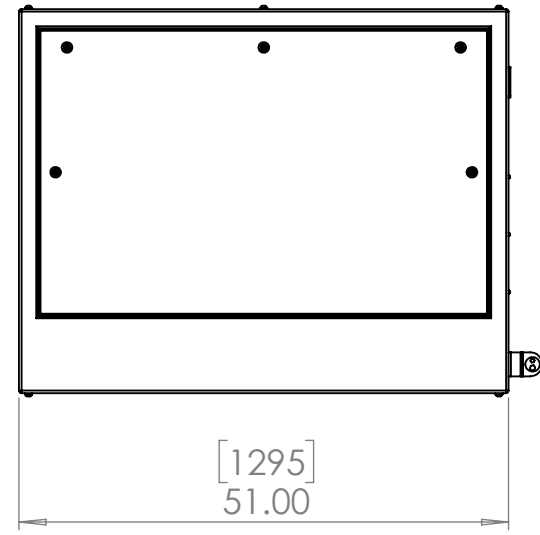
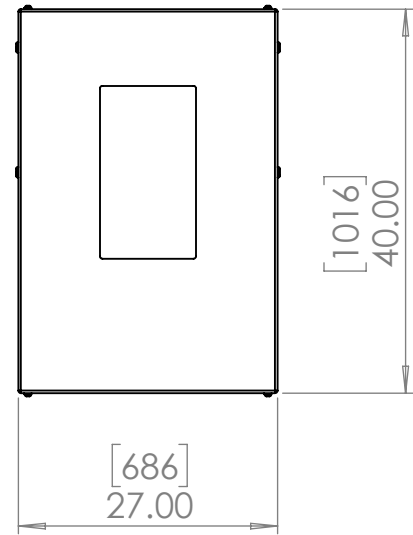
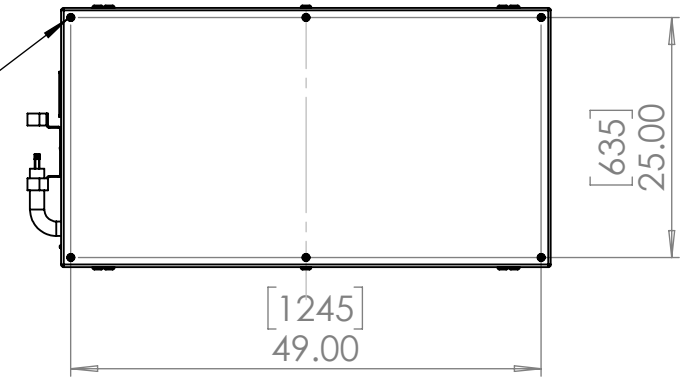

Note: Dimensions subject to change without notice; check with Tempest before construction.

UNLESS OTHERWISE SPECIFIED:  
DIMENSIONS ARE IN INCHES  
TOLERANCES:  
FRACTIONAL ±  
ANGULAR: MACH ± BEND ±  
TWO PLACE DECIMAL ±  
THREE PLACE DECIMAL ±  
INTERPRET GEOMETRIC TOLERANCING PER:  
MATERIAL  
Aluminum  
FINISH  
TBD

	NAME	DATE
DRAWN	TB	8/2/2022
CHECKED		
ENG APPR.		
MFG APPR.		
Q.A.		
COMMENTS:		



TITLE: Oasis 305 Portrait Enclosure (12k)		
SIZE <b>B</b>	DWG. NO. 59.305.P	REV 01
SCALE: 1:20		SHEET 1 OF 1

DO NOT SCALE DRAWING