

Line Set (high-pressure pipes and cooler control cable), choose from:

- 59.LS.09.03 - 3m [10ft] [] (default)
- 59.LS.09.05 - 5m [16ft] []
- 59.LS.09.08 - 8m [25ft] []
- 59.LS.09.10 - 10m [33ft] []
- 59.LS.09.15 - 15m [50ft] []

For single-zone systems, see ODU drawing 59.ODU.09

For multi-zone systems, consult Tempest for ODU specification.

Rigging Points:
M12-1.75,
6 places Top
4 Places Bottom

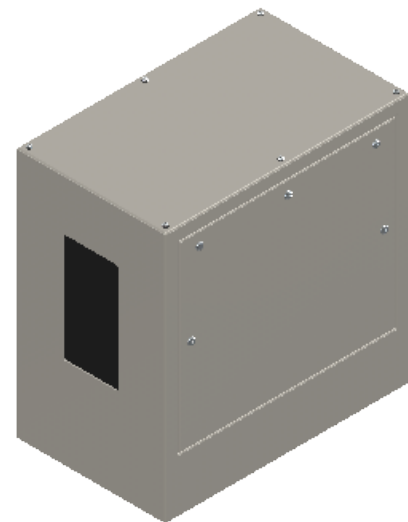
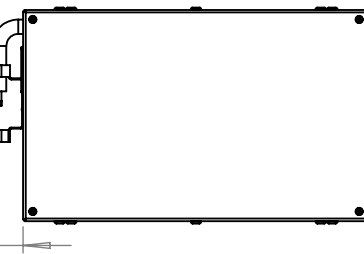
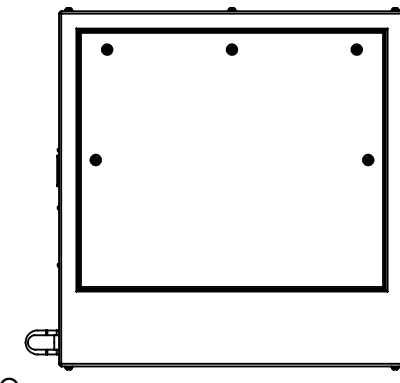
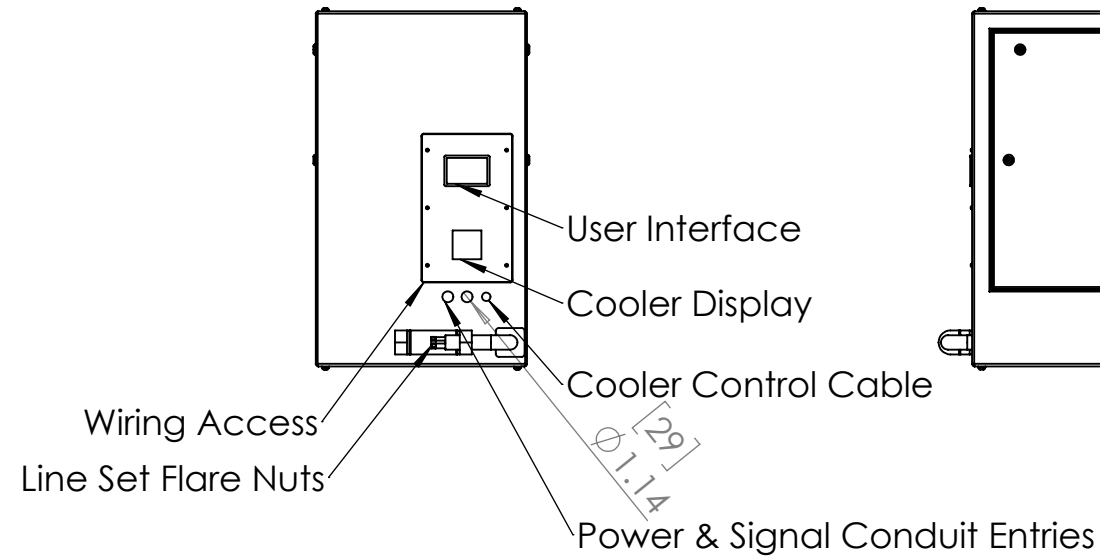
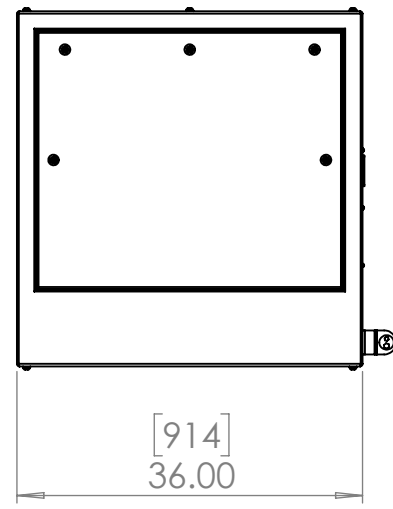
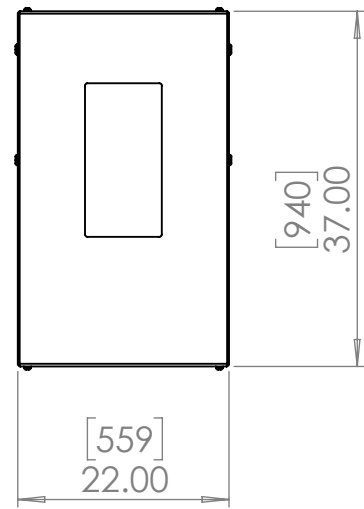

Note: Dimensions subject to change without notice; check with Tempest before construction.

UNLESS OTHERWISE SPECIFIED:
DIMENSIONS ARE IN INCHES
TOLERANCES:
FRACTIONAL ±
ANGULAR: MACH ± BEND ±
TWO PLACE DECIMAL ±
THREE PLACE DECIMAL ±
INTERPRET GEOMETRIC TOLERANCING PER:
MATERIAL
Aluminum
FINISH
TBD

	NAME	DATE
DRAWN	TB	8/2/2022
CHECKED		
ENG APPR.		
MFG APPR.		
Q.A.		
COMMENTS:		



TITLE: Oasis 125 Portrait Enclosure (9k)		
SIZE B	DWG. NO. 59.125.P	REV 02
SCALE: 1:20		SHEET 1 OF 1

DO NOT SCALE DRAWING