

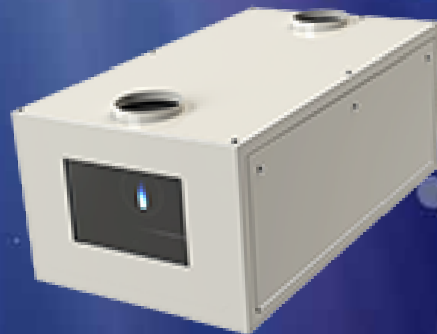

TEMPEST

**Tacit**  
Hush  
Projector  
Enclosures  
5-50K



# Tacit Hush Projector Enclosures

Tempest is the world's leading manufacturer of large format indoor projector enclosures for noise attenuation in presentation suites, digital cinema, live theatre and concert venues – any noise-sensitive indoor space. Larger Tacit models are projector-specific for projectors above 20K lumens, and have been tested and approved for each of the projectors covered, up to 50,000 ANSI lumens.



*Tacit 56.310 Landscape with a Christie Crimson projector*

*Tip: You can specify most Tacit models to slide left or right*

**New:**  
Four full-featured Tacit models are now available for most projectors between 5-15,000 ANSI Lumens.

Tacit uses a thermostatically controlled remote fan located in an adjacent space or insulated ceiling void to assure best-in-class noise attenuation. Tacit has a lightweight but extremely strong aluminum frame, with threaded holes top and bottom for easy installation.

Tacit offers excellent projector access, with full-length lockable side access doors, and a projector slide that may be ordered for right or left access on all landscape and portrait models.

Standard colors: White (RAL 9003 semi-gloss) or black. Other colors to order.

Tacit is equipped with Tempest's patented DEC4 Control, featuring a comprehensive display and remote monitoring options.

Portrait and Ultra-Short-Throw versions are available to special order.

## Why so Quiet?

There are several parts to the puzzle:

- First, Tacit enclosures are airtight boxes with excellent seals, which do much of the work.
- Second, we line Tacit enclosures with two layers of high performance melamine sound insulation foam — rated incidentally to the highest fire safety standards.
- Third, we put the exhaust fan someplace else. As a rule of thumb, you need to blow through an enclosure about double the amount of air being handled by the projector itself.

That means forced cooling, and that means noise. The Tacit exhaust fan is located at the end of a duct (by others), which may be in an insulated ceiling space, an adjoining room or an outside wall.

The exhaust fan may also feed into the building air return, though we don't recommend feeding air to the enclosure inlets from the building air supply. It should be brought in at moderate temperature from a room or ceiling void.

This combination achieves excellent attenuation in the audience space, which is our sole aim.

*Now Tempest Tacit enclosures monitor air temperature where it matters — right next to the projector air inlet. You can set a target air inlet temperature limit, and Tacit's variable speed remote fan will blow just hard enough to keep it there.*

*You told us that our user interface was great, but that it could be distracting or hard to reach on the outside. So now it's right where you need it, next to the projector.*



# Tacit Hush Projector Enclosures

## Landscape

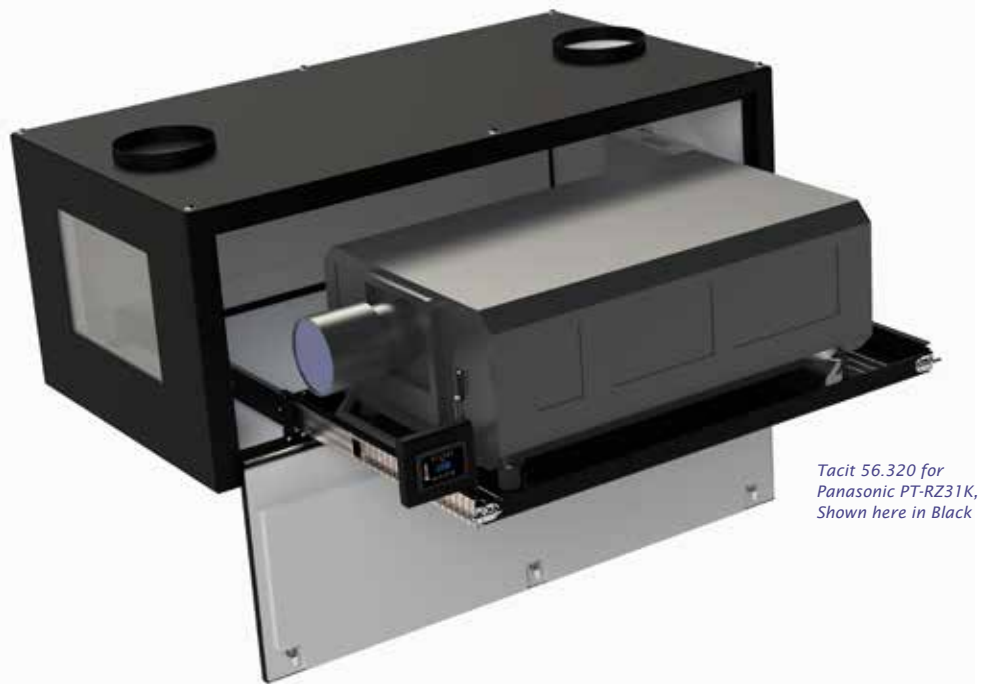
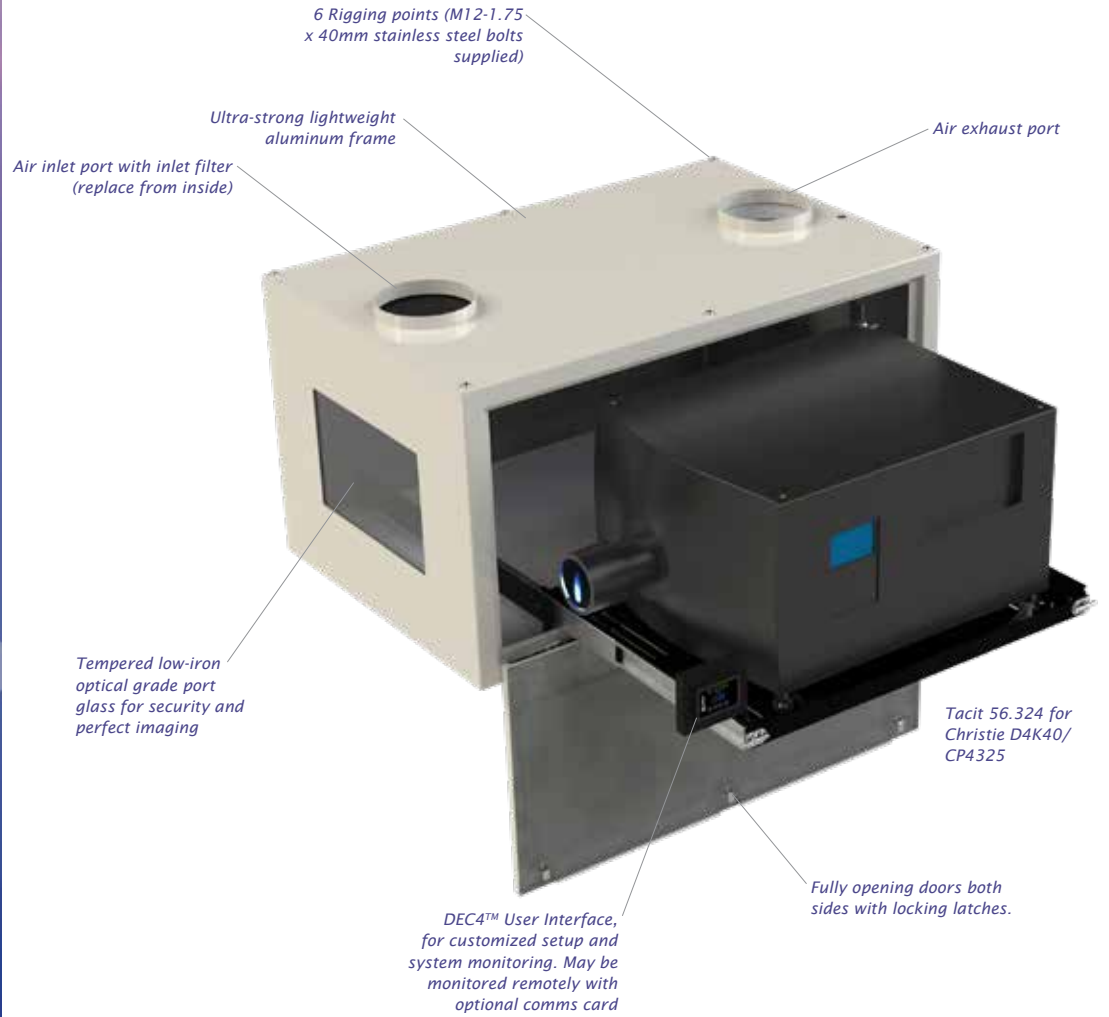

# Tacit Hush Projector Enclosures

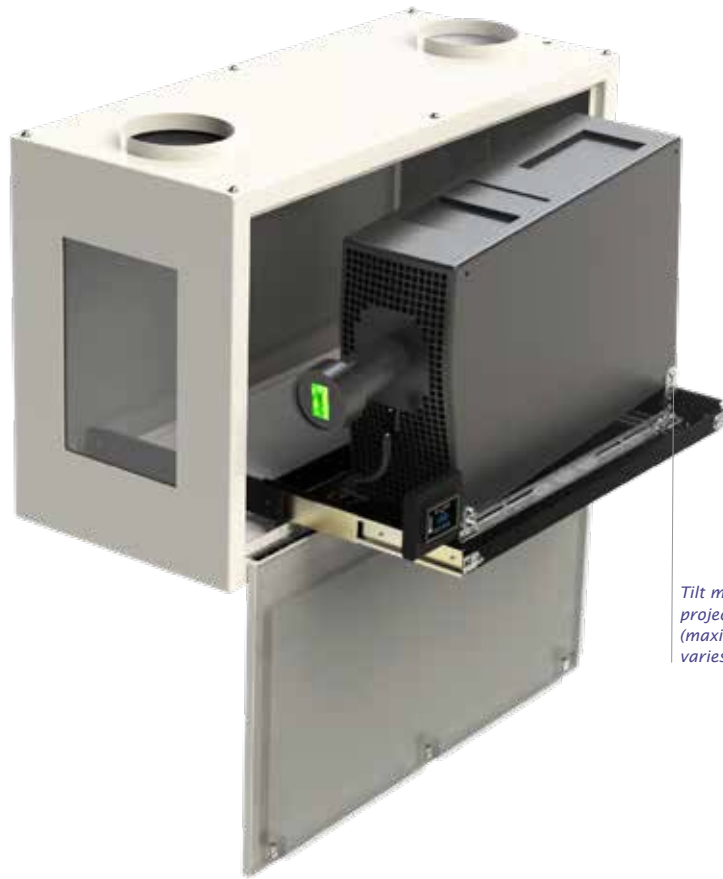

## Portrait

Like all Tacit models, each Tacit portrait enclosure is customized for the intended projector, so we need to know the projector you're using when you order.

Not all projectors may be used in portrait mode — check with your projector manufacturer before ordering.

Some projectors may be used in portrait mode but only in one orientation — either base left or base right (picture here shows a Christie Crimson installed base left).

*Tilt mechanism allows projector tilt adjustment (maximum tilt angle varies by projector).*

## Ultra Short Throw



Tacit UST enclosures allow you to paint the whole wall from just above or below. UST enclosures are wider than standard landscape enclosures, to allow for the extreme width of the projection beam without clipping.

Tacit UST enclosures may be configured to mount above the image (projecting down) or below it (projecting up). Due to the wide variety of UST lens solutions on the market, Tacit UST enclosures are specially

built for your project: Contact Tempest and talk to us about your next UST adventure!

# Tacit

Hush  
Projector  
Enclosures



## Tacit Remote Blower Kit

51.RFA.220 (Tacit 050-150)

51.RFA.270 (Tacit 210 and up)

Tacit's powerful remote blower must be located in an adjoining space to the Tacit enclosure, out of audience earshot. Connection to the enclosure is via one 2-conductor power cable (48Vdc, 120W), and one twisted pair for speed control and status feedback — a CAT5 cable is fine. The cable may be pulled back to the enclosure through the exhaust duct if desired.

Mount the blower kit either in a convenient space in free air, or in the side of a building return HVAC duct.

## Fan Speed Control

Tacit uses a powerful variable-speed blower in a remote location to keep the projector at optimum operating temperature.

The remote blower will run at the minimum speed required to maintain the target projector inlet temperature, keeping fan noise to a minimum and enabling virtually infinite fan life.

Tacit's temperature sensor is now located exactly where you need it — right by the projector's inlet vent, and user settings allow you to set a target inlet temperature to suit the needs of your projector.

## Ductwork (by others)

For best results, install 250mm (10") air ducts for air inlet and exhaust (200mm/8in for Tacit 050-150).

The exhaust duct should be as short as possible (maximum 10m/30ft), and with a minimum of sharp bends, to optimize airflow.

The inlet duct should ideally connect to an adjoining air-conditioned space, for best cooling and acoustic performance. DO NOT pull air from the building HVAC supply if it may be used for heating as well as air conditioning.

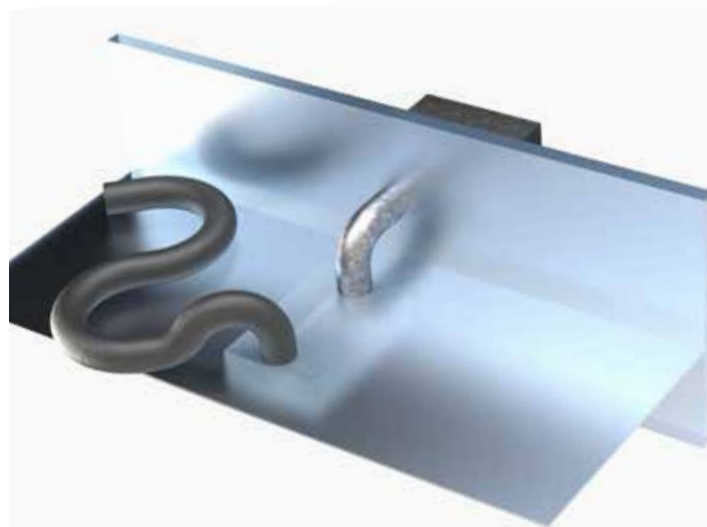
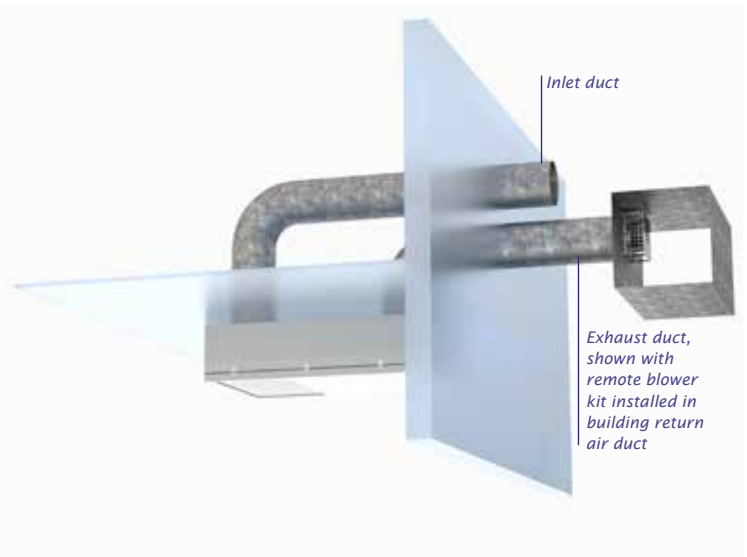

If it is impractical to bring inlet air from a remote location, use a length of padded flexible hose (250mm/10in ID) in an 'S' configuration to draw in air and muffle any noise escaping through the air inlet path.

In cases where additional ductwork is not feasible such as in historic buildings, consider Tempest's *Zen* standalone enclosures.

# Tacit Hush Projector Enclosures

Tempest System Manager is a Windows app running on a local PC connected to your enclosures over a local area network.

TSM discovers any Tempest enclosures present on the network at initialization, and monitors system attributes in real time, including lamp, fan and heater status, temperature, relative humidity and more.

TSM may also be used to upload firmware updates to enclosure controllers over the network, without having to visit each enclosure.

The TSM license includes 12 months unlimited user support from Tempest electronics partner JESE, and continuing support is available for a modest annual fee.

## Monitoring Connections

There are two ways to connect enclosures to the TSM PC:

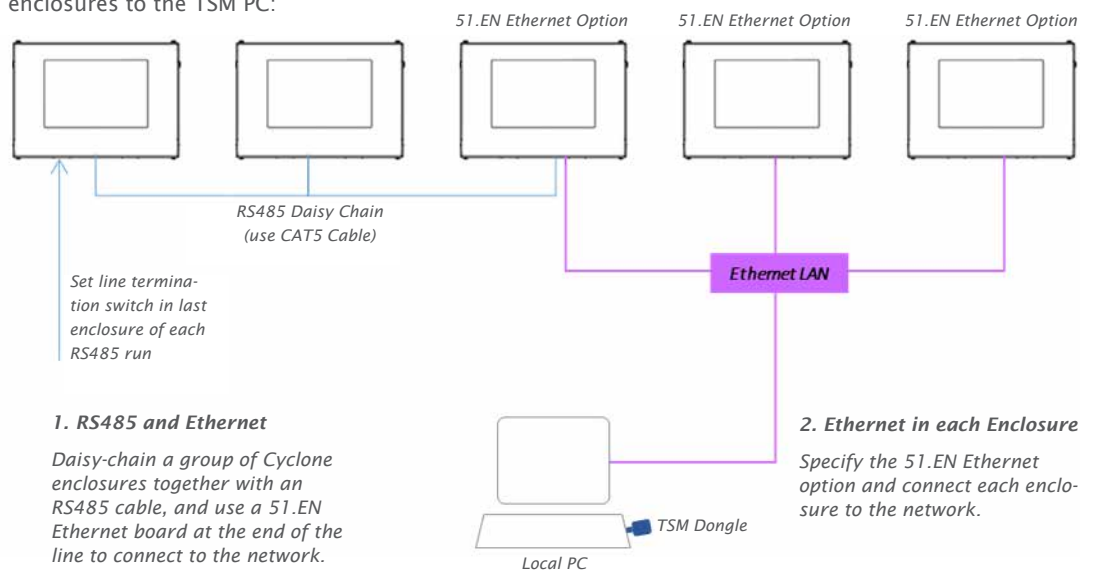

# Tempest System Manager

Index	Description	Label	Status	Voltage	Current	RH%	Temp °C	Htr %	Fan %
1	DEC4 Controller	Cyclone 310 Left 1	Lamp On	231V	12.2A	45.7%	23.4°C	0.0%	100.0%
2	DEC4 Controller	Cyclone 310 Left 2	Lamp on	231V	12.2A	46.0%	23.8°C	0.0%	100.0%
3	DEC4 Controller	Cyclone 310 Left 3	Override	231V	0.0A	49.4%	22.6°C	0.0%	0.0%
4	DEC4 Controller	Cyclone 310 Left 4	Tripped	231V	0.1A	1.2%	66.2°C	0.0%	100.0%
5	DEC4 Controller	Cyclone 310 Left 5	Lamp on	231V	12.2A	46.1%	23.4°C	0.0%	100.0%
6	DEC4 Controller	Cyclone 310 Left 6	Lamp on	231V	12.2A	46.3%	23.5°C	0.0%	100.0%
7	DEC4 Controller	Cyclone 310 Right 1	Lamp on	231V	12.2A	46.4%	23.8°C	0.0%	100.0%
8	DEC4 Controller	Cyclone 310 Right 2	Lamp on	231V	12.2A	46.3%	23.5°C	0.0%	100.0%
9	DEC4 Controller	Cyclone 310 Right 3	Lamp on	231V	12.2A	46.0%	23.2°C	0.0%	100.0%
10	DEC4 Controller	Cyclone 310 Right 4	Lamp on	231V	12.2A	46.1%	23.1°C	0.0%	100.0%
11	DEC4 Controller	Cyclone 310 Right 5	Lamp on	231V	12.2A	46.0%	23.7°C	0.0%	100.0%
12	DEC4 Controller	Cyclone 310 Right 6	Lamp on	231V	12.2A	46.2%	23.4°C	0.0%	100.0%
13	DEC4 Controller	ard 100 UST 1	Standby	231V	0.2A	51.3%	22.1°C	0.0%	0.0%
14	DEC4 Controller	ard 100 UST 2	Standby	231V	0.2A	51.8%	22.0°C	0.0%	0.0%
15	DEC4 Controller	ard 100 UST 3	Standby	231V	0.2A	51.4%	22.2°C	0.0%	0.0%
16	DEC4 Controller	ard 100 UST 4	Standby	231V	0.2A	51.3%	22.3°C	0.0%	0.0%
17	DEC4 Controller	ard 100 UST 5	Standby	231V	0.2A	51.3%	21.8°C	0.0%	0.0%
18	DEC4 Controller	ard 100 UST 6	Standby	231V	0.2A	51.6%	22.1°C	0.0%	0.0%
19	DEC4 Controller	ard 100 UST 7	Standby	231V	0.2A	51.5%	21.4°C	0.0%	0.0%
20	DEC4 Controller	Blizzard 100 UST 8	Standby	231V	0.2A	51.7%	22.2°C	0.0%	0.0%

## TSM Model Numbers

- 51.TSM.10 Up to 10 enclosures
- 51.TSM.25 Up to 25 enclosures
- 51.TSM.50 Over 25 enclosures



# TEMP Protocol

Tempest also publishes a simple protocol for use by integrators wishing to monitor enclosures over an existing control network.

Connection options are the same as for System Manager.

Download the TEMP Developer Guide [here](#):

# Tacit Ordering Guide

Model	Orientation	Dimensions (lwh)	Weight	Projector Type/max size <sup>1</sup>	Shipping Dimensions/Weight
56.050.L	Landscape	29x30x15in 74x76x37cm	59lb/27kg	22x22.5x9in/56x57x23cm (most @ 5-8k lumens)	36x36x24in/91x91x61cm 94b/43kg
56.050.P	Portrait	29x17x28in 74x43x71cm	64lb/29kg		36x36x24in/91x91x61cm 99lb/45kg
56.100.L	Landscape	34x32x16in 86x81x39cm	85lb/39kg	27x24.5x10in/69x62x-25cm (most 8-12k lumens)	36x36x24in/91x91x61cm 120lb/55kg
56.100.P	Portrait	34x17x30in 86x43x76cm	95lb/43kg		36x36x24in/91x91x61cm 130lb/59kg
56.125.L	Landscape	34x36x16in 86x91x39cm	94lb/43kg	27x28.5x10in/69x72x-25cm (wider 8-12k lumens)	36x42x24in/91x107x61cm 129b/59kg
56.125.P	Portrait	34x17x34in 86x43x86cm	104lb/47kg		36x42x24in/91x107x61cm 139lb/63kg
56.150.L	Landscape	42x32x18in 107x81x44cm	106lb/48kg	Barco F80, F90, Christie H/HS Series, DPI M-Vision 930, Epson L-1700, Panasonic PT-RS11, RZ12, RQ13	55x42x35in/135x107x89cm 242lb/110kg
56.150.P	Portrait	42x19x32in 107x48x81cm	118lb/65kg		55x32x43in/135x81x109cm 233lb/106kg
56.210.L	Landscape	51x32x22in 130x81x56cm	177lb/80kg	Panasonic PT-DZ21K, PT-RZ12K, PT-RQ13, PT-RZ21K, Barco UDM, F90-W13, DPI Highlight 4K	60x42x35in/152x107x89cm 297lb/135kg
56.210.P	Portrait	51x25x34in 130x64x86cm	213lb/97kg		60x35x47in/152x89x119cm 333lb/151kg
56.250.L	Landscape	51x37x24in 130x94x61cm	223lb/101kg	Epson Pro L25000U	60x47x37in/152x119x94cm 363lb/165kg
56.250.P	Portrait	51x25x41in 139x64x104cm	257lb/117kg		60x35x54in/152x89x137cm 397lb/181kg
56.305.L	Landscape	51x34x24in 130x86x61cm	205lb/93kg	Panasonic PT-RQ35K, PT-RZ34K, Epson L20000	60x44x37in/152x112x94cm 345lb/157kg
56.305.P	Portrait	51x25x36in 130x64x91cm	226lb/103kg		60x35x49in/152x89x124cm 366lb/166kg
56.310.L	Landscape	59x34x25in 150x86x64cm	254lb/115kg	Christie Boxer, Crimson, Barco UDX	68x44x38in/173x112x97cm 387lb/176kg
56.310.P	Portrait	59x25x36in 150x64x91cm	261lb/119kg		68x35x49in/173x89x124cm 401lb/182kg
56.314.L	Landscape	58x37x27in 147x94x69cm	285lb/130kg	Christie Griffyn	67x47x40in/170x119x102cm 425lb/193kg
56.314.P	Portrait	58x25x38in 147x64x97cm	271lb/123kg		67x35x51in/170x89x130cm 411lb/187kg
56.320.L	Landscape	67x37x25in 170x94x65cm	305lb/139kg	Panasonic PT-RZ31K, RQ32K,	76x47x38in/193x119x97cm 455b/207kg
56.320.P	Portrait	67x25x40in 170x64x102cm	313lb/142kg		76x38x53in/193x89x135cm 463lb/210kg
56.324.L	Landscape	58x37x34in 147x94x86cm	359lb/163kg	Christie CP4325, D4K40-RGB	67x47x47in/170x119x119cm 529lb/240kg
56.324.P	Portrait	58x30x41in 147x76x104cm	351lb/160kg		67x40x54in/170x102x107cm 521b/237kg
56.400.L	Landscape	62x37x38in 157x94x97cm	440lb/200kg	Barco B-Series	71x48x51in/180x122x130cm 610lb/277kg
56.450.L	Landscape	71x37x38in 180x94x97cm	504lb/229kg	Christie D4K35, CP2220/30	80x48x51in/203x122x130cm 674lb/307kg
56.525.L	Landscape	67x37x29 170x97x74cm	354lb/161kg	Panasonic PT-DZ50K, PT-RQ50K, DPI Insight Dual	76x47x42in/193x119x107cm 534lb/243kg
56.525.P	Portrait	67x30x40 170x76x102cm	376lb/171kg		76x40x53in/193x102x135cm 556lb/253kg

<sup>1</sup> For projectors not shown here, please contact factory — we will be happy to accommodate any projector type

All Tacit Enclosures are built to order. Please consult factory for lead times.

All Tacit UST Enclosures are Custom or Semi-Custom. Please consult factory for details.

All sales are subject to Tempest Lighting, Inc. Standard Terms and Conditions, available for download at [www.tempest.biz](http://www.tempest.biz).

All Schedule B Export Code: 9405.99.0000

## Custom Colors

The enclosures in this brochure are shown in our standard warm white semi-gloss or black. Any RAL color available to special order.

## Options

<b>56.UR.xxx</b>	Unistrut Rail Kit (Use the 3-digit enclosure model #, eg 56.UR.200 for Tacit 56.200)
<b>51.IFL.11</b>	Replacement Inlet Filter Tacit 56.1xx-3xx Models
<b>51.IFL.13</b>	Replacement Inlet Filter Tacit 56.400 and up
<b>51.EN</b>	Ethernet Board, for Tempest TEMP monitoring
<b>51.TSM.xx</b>	Tempest System Manager
<b>0000.CL</b>	Custom Color — specify any RAL #, plus % gloss desired









# Tacit Configurator

Please complete this form and email to us at [info@tempest.biz](mailto:info@tempest.biz)

Name		
Company		
Email		
Phone		
Projector & Lens Model #	Projector:	Lens:
Tacit Model	56. _____	
Quantity		
Destination Country		
Install Date		
Enclosure Type	Landscape <input type="checkbox"/> Portrait <input type="checkbox"/> Ultra Short Throw <input type="checkbox"/>	
Projector Slide	Left (as shown here) <input type="checkbox"/> Right <input type="checkbox"/> Front (custom) <input type="checkbox"/> Back (custom) <input type="checkbox"/>	
Projector Mount	Landscape/UST: Feet Down <input type="checkbox"/> Feet Up <input type="checkbox"/> Portrait: Feet Left <input type="checkbox"/> Feet Right <input type="checkbox"/>	
Unistrut Kit	Yes, Qty _____ No <input type="checkbox"/>	
Ethernet Bridge	Yes, Qty _____ No <input type="checkbox"/>	
Spare Inlet Filter	Yes, Qty _____ No <input type="checkbox"/>	
Color	Standard, Warm White <input type="checkbox"/> Standard, Black <input type="checkbox"/> Custom, RAL # _____  Gloss Level * _____% <i>* Gloss levels higher than 30% may show up weld marks. Tempest advises against high gloss finishes and accepts no liability in this event.</i>	

Projector Power Outlet (all types include 2 x IEC 60320 C13 Aux Power):  
 IEC 60320 C19 20Amp \_\_\_\_\_   
 IEC 60309 30/32Amp \_\_\_\_\_   
 Custom (specify) \_\_\_\_\_

UST Lens Configuration:

		
90deg Up <input type="checkbox"/>	90deg Down <input type="checkbox"/>	Periscopic A <input type="checkbox"/>
		
90deg Right <input type="checkbox"/>	90deg Left <input type="checkbox"/>	Periscopic B <input type="checkbox"/>
		
Straight, Vshift Down <input type="checkbox"/>		Straight, Vshift Up <input type="checkbox"/>

Custom Requests:

Factory Use Only:	
SO Number	
Date	
Electrical	IEC <input type="checkbox"/> NEMA <input type="checkbox"/>



User manuals,  
2D and 3D CAD  
drawings at  
[www.tempest.biz](http://www.tempest.biz)