

For Remote Blower unit,
see drawing #
51.RFA.220.xxx

Rigging Points:
M10-1.5, 4 places
top and bottom

Inlet Duct Ring

Power & Signal Conduit Entries

Exhaust Duct Ring

Optical
Grade
low-iron
port glass

Access door
both
sides,
with
security
latches

Alternate Conduit Entries

Wiring Access Panel

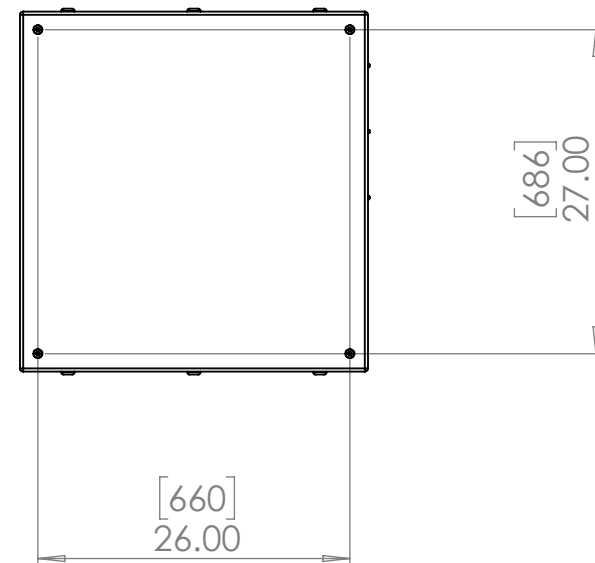
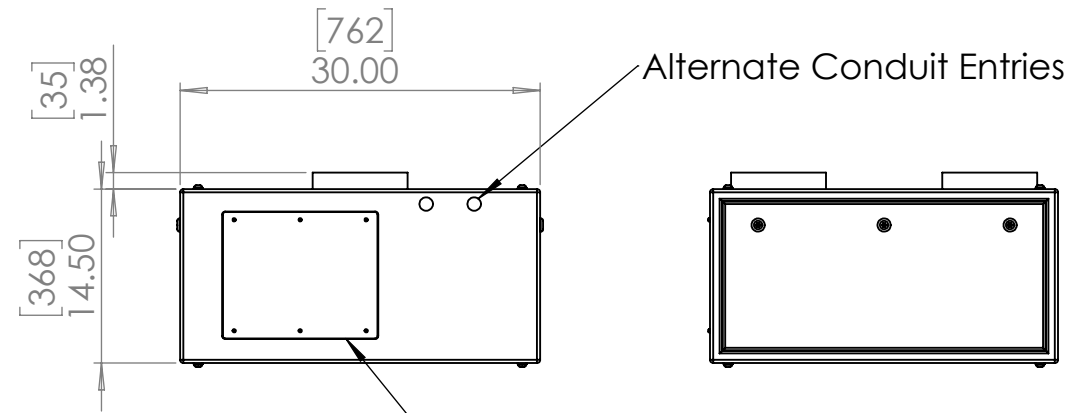
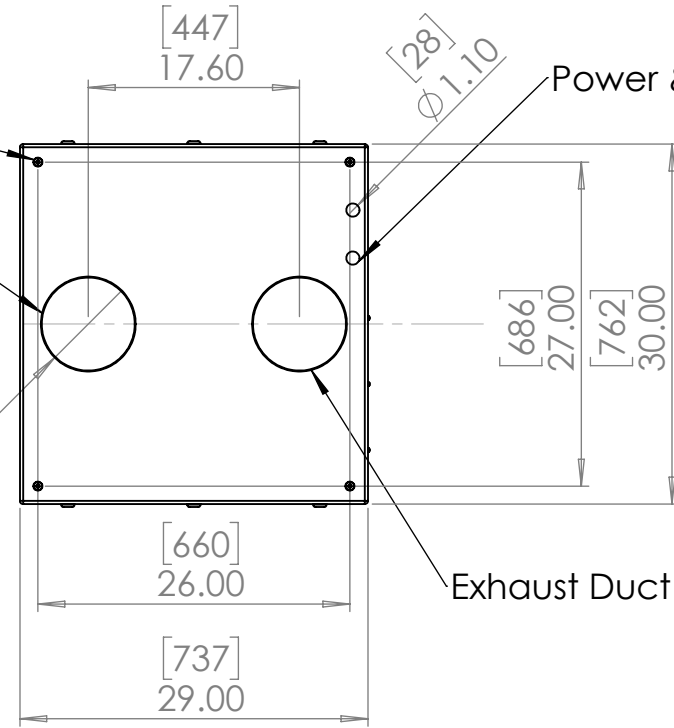
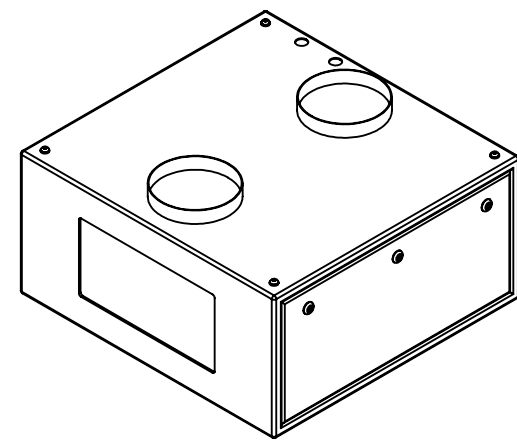

UNLESS OTHERWISE SPECIFIED:
DIMENSIONS ARE IN INCHES
TOLERANCES:
FRACTIONAL ±
ANGULAR: MACH ± BEND ±
TWO PLACE DECIMAL ±
THREE PLACE DECIMAL ±
INTERPRET GEOMETRIC
TOLERANCING PER:

MATERIAL

FINISH

DO NOT SCALE DRAWING

	NAME	DATE
DRAWN	TB	7/16/2020
CHECKED		
ENG APPR.		
MFG APPR.		
Q.A.		
COMMENTS:		



TITLE:
Whispr 53.050 Landscape
Enclosure

SIZE	DWG. NO.	REV
B	53.050.Lx.xx	6.1

SCALE: 1:20 SHEET 1 OF 1