

For Remote Fan  
Module, see  
drawing #  
51.RFA.220.PWM

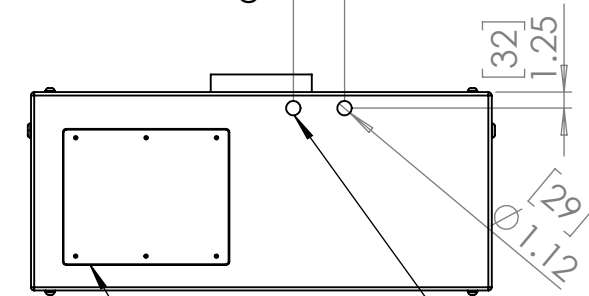
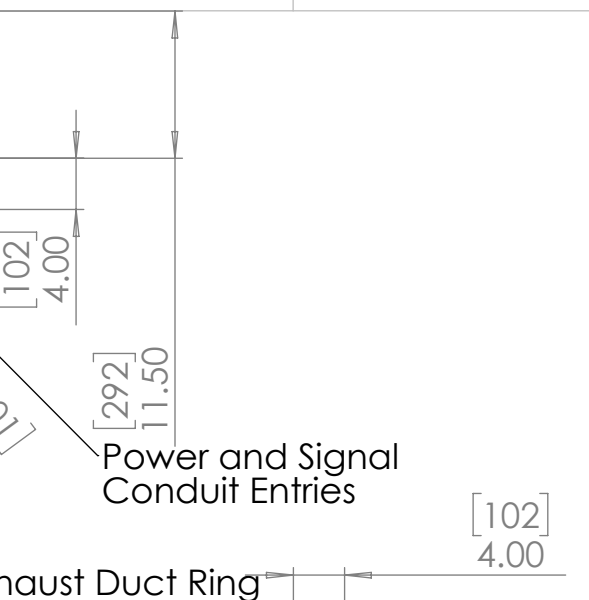
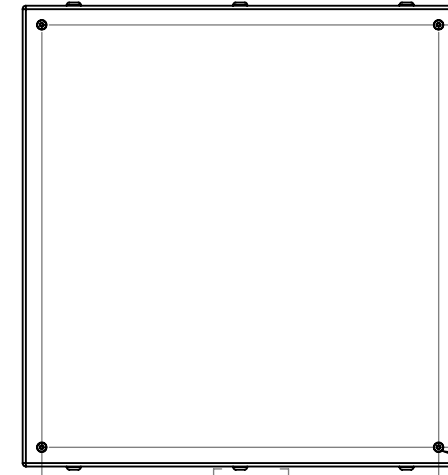
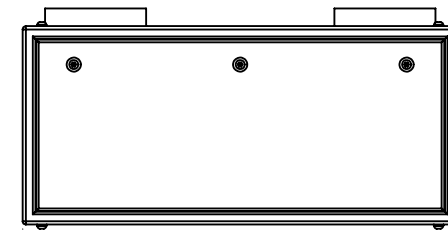
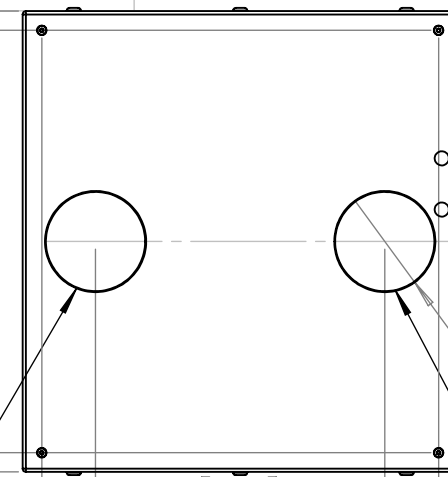
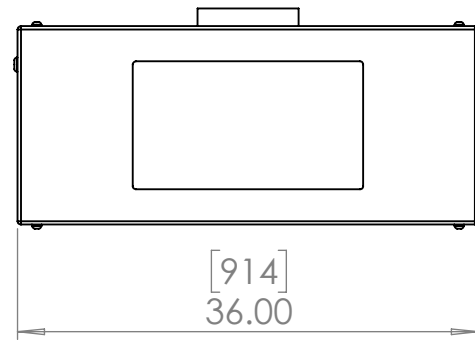
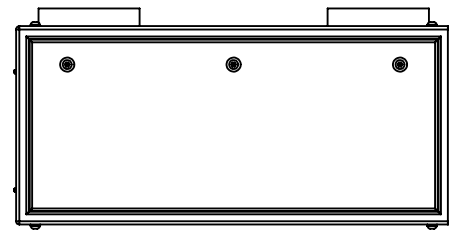
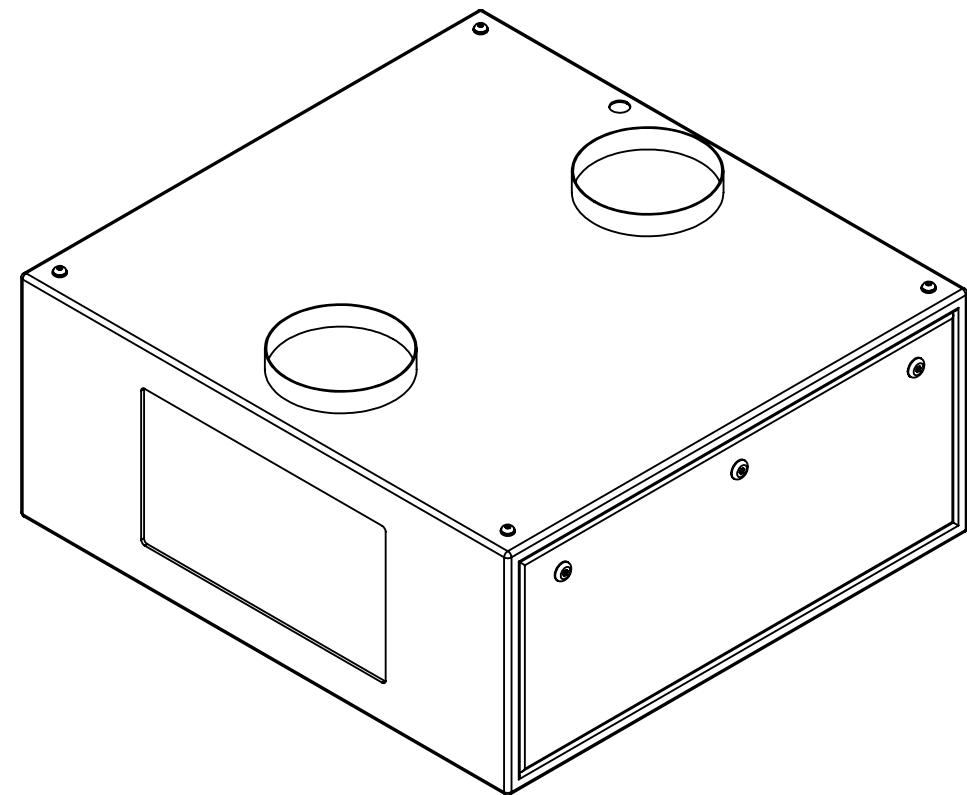

Inlet Duct Ring

Power and Signal  
Conduit Entries

Exhaust Duct Ring

Wiring  
Access  
Panel

Alternate  
Conduit  
Entries

Rigging Points:  
M10-1.5, 4 places  
Top and Bottom

UNLESS OTHERWISE SPECIFIED:  
DIMENSIONS ARE IN INCHES  
TOLERANCES:  
FRACTIONAL ±  
ANGULAR: MACH ± BEND ±  
TWO PLACE DECIMAL ±  
THREE PLACE DECIMAL ±  
INTERPRET GEOMETRIC  
TOLERANCING PER:  
MATERIAL  
FINISH  
DO NOT SCALE DRAWING

	NAME	DATE
DRAWN	TB	7/7/2020
CHECKED		
ENG APPR.		
MFG APPR.		
Q.A.		
COMMENTS:		



TITLE:  
Tacit 56.125 Landscape  
Enclosure

SIZE <b>B</b>	DWG. NO. 56.125.Lx.xx	REV 6.1
------------------	--------------------------	------------

SCALE: 1:20 SHEET 1 OF 1