

8 7 6 5 4 3 2 1

D  
C  
B  
A

D  
C  
B  
A

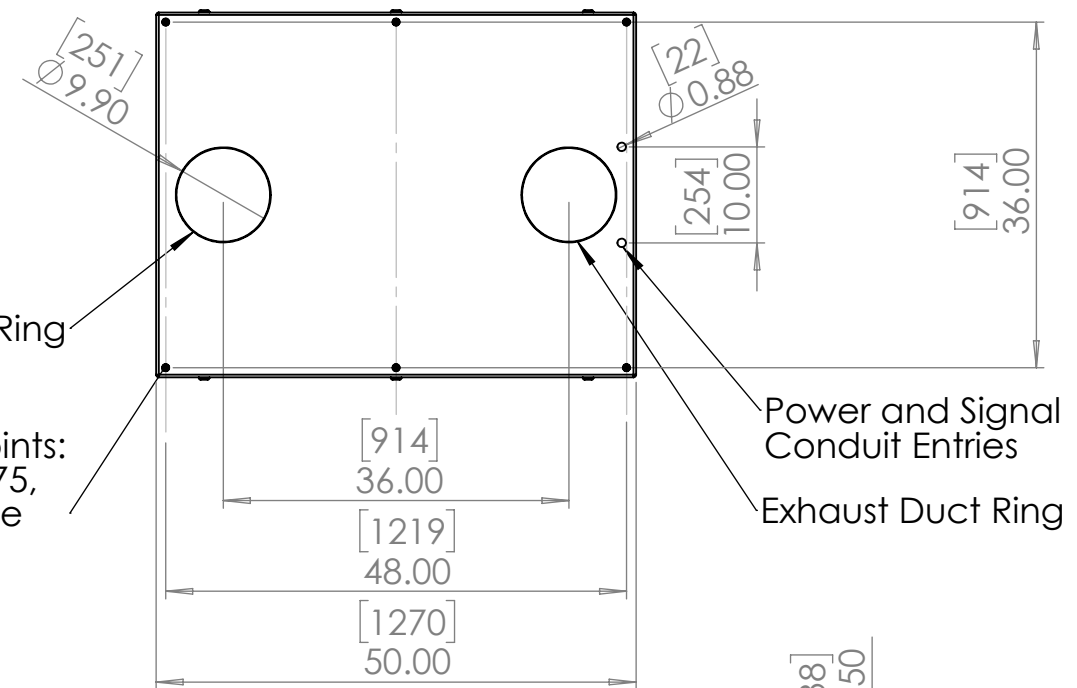

Inlet Duct Ring

Rigging Points:  
6 x M12-1.75,  
Top Surface

Power and Signal  
Conduit Entries

Exhaust Duct Ring

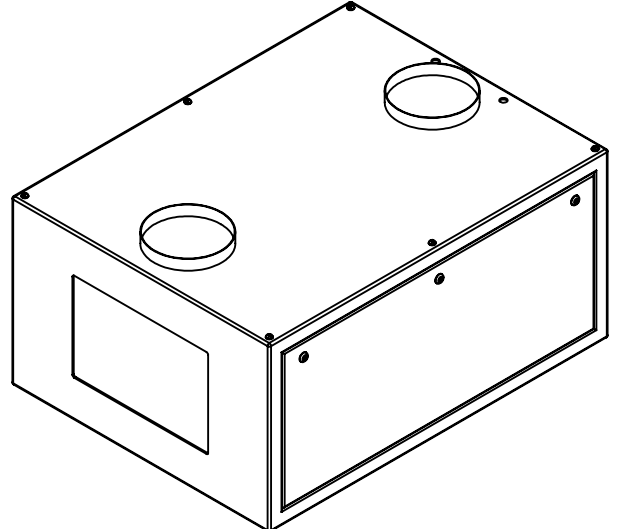
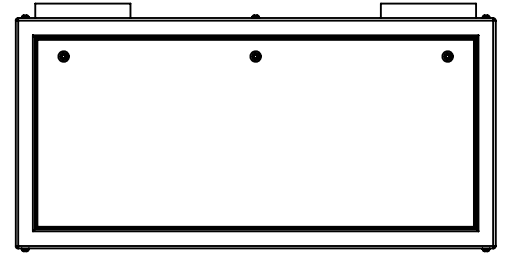
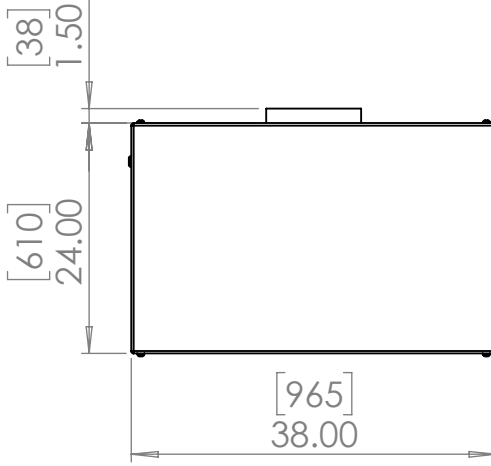
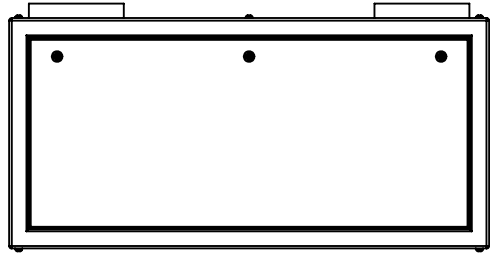
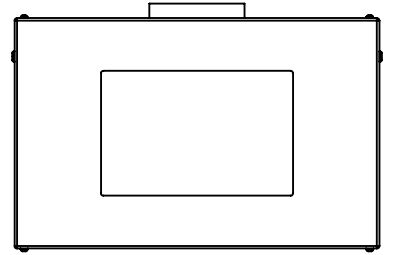

Rigging Points:  
M12-1.75, 4  
places, Bottom  
Surface



UNLESS OTHERWISE SPECIFIED:  
DIMENSIONS ARE IN INCHES  
TOLERANCES:  
FRACTIONAL  $\pm$   
ANGULAR: MACH  $\pm$  BEND  $\pm$   
TWO PLACE DECIMAL  $\pm$   
THREE PLACE DECIMAL  $\pm$   
INTERPRET GEOMETRIC  
TOLERANCING PER:

MATERIAL  
Aluminum

FINISH  
TBD

DO NOT SCALE DRAWING

	NAME	DATE
DRAWN	TB	8/5/2019
CHECKED		
ENG APPR.		
MFG APPR.		
Q.A.		
COMMENTS:		



**TEMPEST**  
lighting inc.

TITLE:  
Tacit 56.250 Landscape  
Enclosure

SIZE <b>B</b>	DWG. NO. 56.250.L	REV 7.1
------------------	----------------------	------------

SCALE: 1:20 SHEET 1 OF 1

8 7 6 5 4 3 2 1