

8 7 6 5 4 3 2 1

D  
C  
B  
A

D  
C  
B  
A

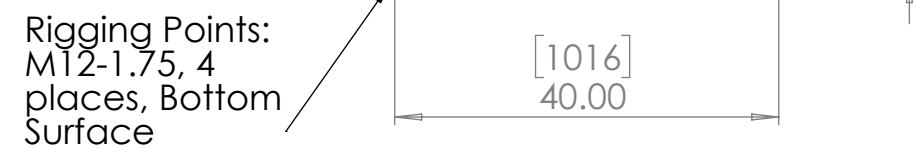
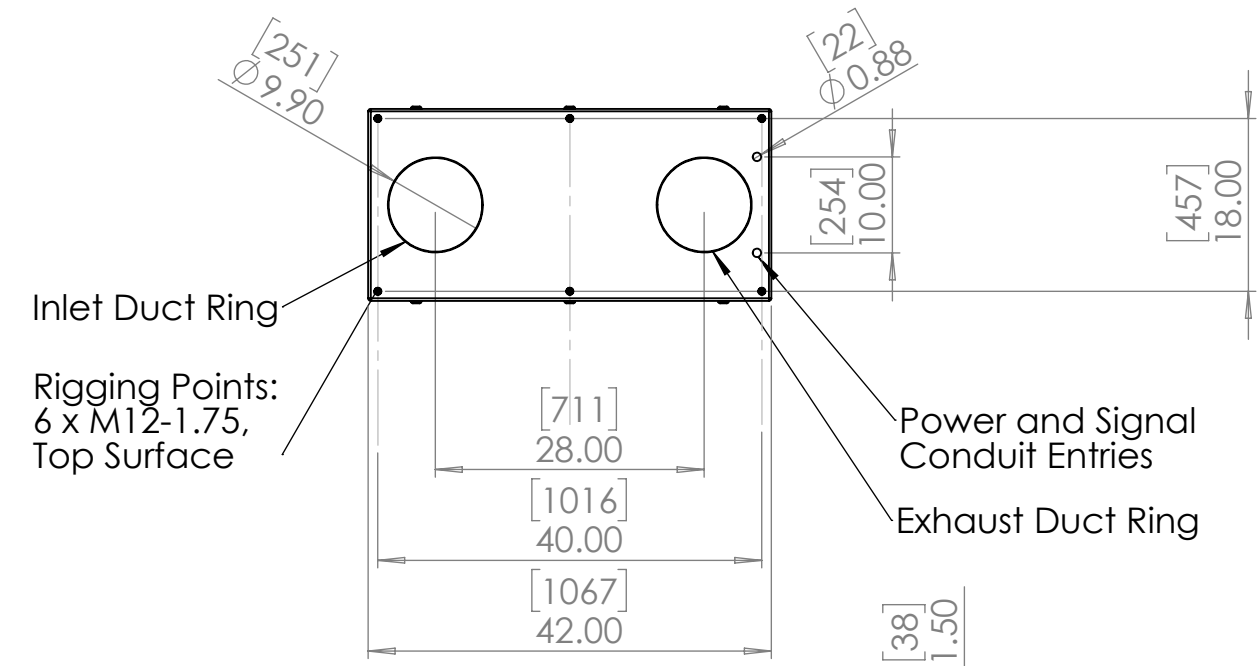
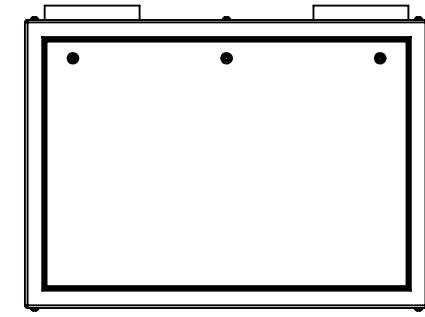
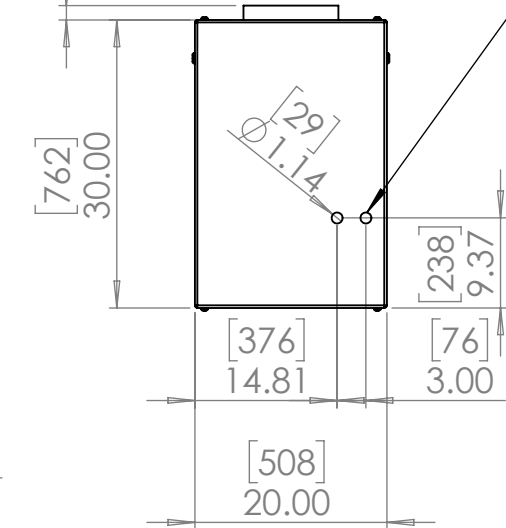
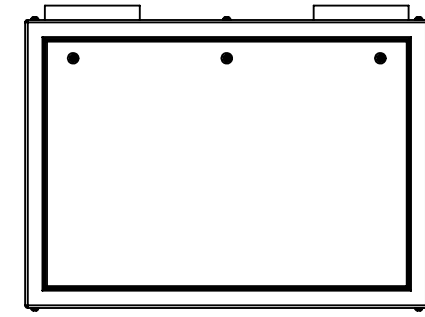
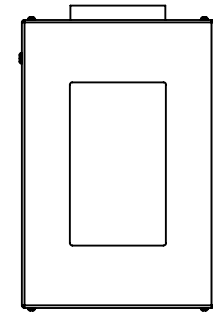
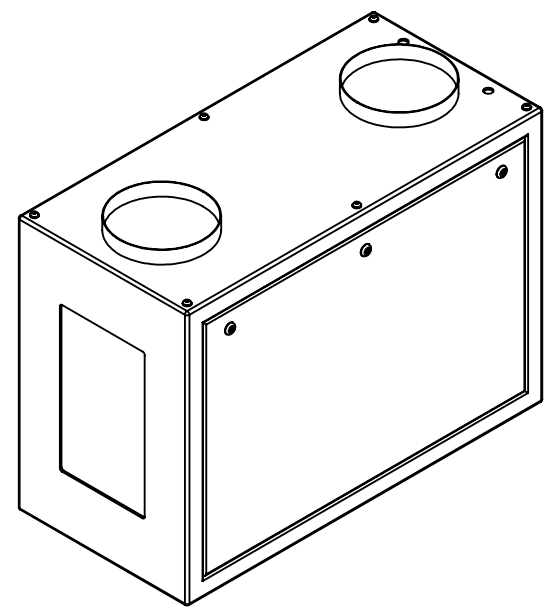

UNLESS OTHERWISE SPECIFIED:  
 DIMENSIONS ARE IN INCHES  
 TOLERANCES:  
 FRACTIONAL ±  
 ANGULAR: MACH ± BEND ±  
 TWO PLACE DECIMAL ±  
 THREE PLACE DECIMAL ±  
 INTERPRET GEOMETRIC TOLERANCING PER:  
 MATERIAL  
 Aluminum  
 FINISH  
 TBD  
 DO NOT SCALE DRAWING

	NAME	DATE
DRAWN	TB	8/5/2019
CHECKED		
ENG APPR.		
MFG APPR.		
Q.A.		
COMMENTS:		



**TEMPEST**  
lighting inc.

TITLE:  
Tacit 56.150 Portrait Enclosure

SIZE <b>B</b>	DWG. NO. 56.150.P	REV 7.1
------------------	----------------------	------------

SCALE: 1:20 SHEET 1 OF 1