

8 7 6 5 4 3 2 1

D
C
B
A

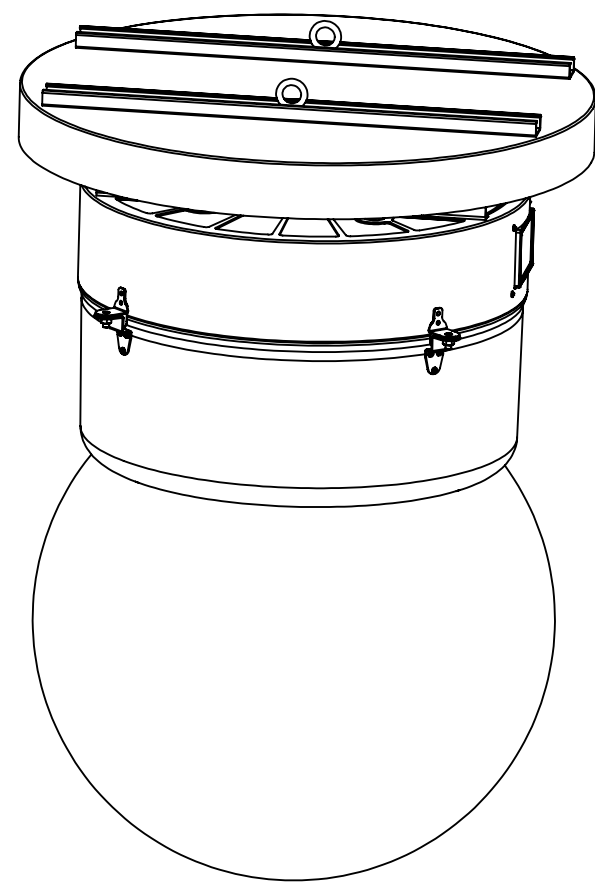

Eyebolts for safety cable where required

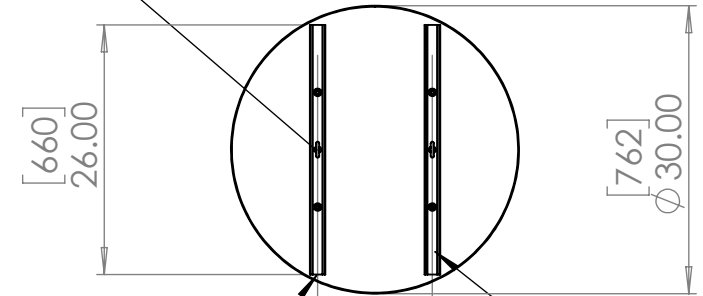

Stainless Steel Unistrut Mounting Rails



Fix to structure using 4 x M12 stainless steel bolts and spring nuts (supplied)

Marine Grade Stainless Steel Latches

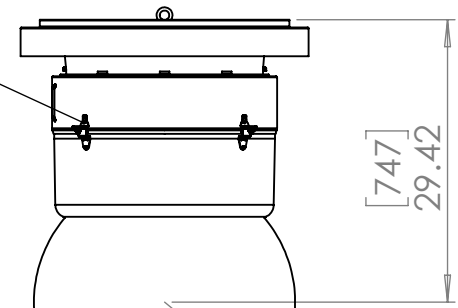

UV-resistant Acrylic Globe



Aluminum Rain Cover

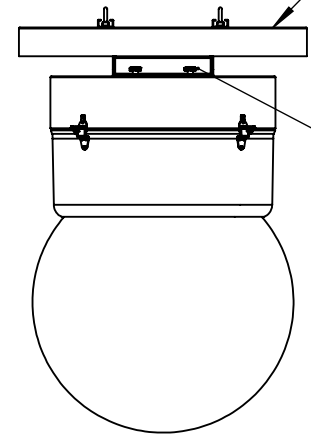

Hydrophobic HEPA filter slides out for service/replacement

UNLESS OTHERWISE SPECIFIED:
 DIMENSIONS ARE IN INCHES
 TOLERANCES:
 FRACTIONAL ±
 ANGULAR: MACH ± BEND ±
 TWO PLACE DECIMAL ±
 THREE PLACE DECIMAL ±
 INTERPRET GEOMETRIC TOLERANCING PER:
 MATERIAL
 Aluminum & Stainless Steel
 FINISH
 Powder Coat RAL9003, Gloss
 DO NOT SCALE DRAWING

	NAME	DATE
DRAWN	TB	5/26/2016
CHECKED		
ENG APPR.		
MFG APPR.		
Q.A.		
COMMENTS:		



TEMPEST
lighting inc.

TITLE: Tornado Marine 1925 Lighting Enclosure, Globe Down

SIZE	DWG. NO.	REV
B	1925.xxMV	01

SCALE: 1:20 SHEET 1 OF 1

8 7 6 5 4 3 2 1